



Procedures for Capacity Model

Complementary document (handbook) to Description of the Timetabling and Capacity Redesign Process

Version 2.4



RailNetEurope
Austria Campus 3
Jakov-Lind-Straße 5
AT-1020 Vienna

Phone: +43 1 907 62 72 00
mailbox@rne.eu
www.rne.eu

Contents

1. Introduction and scope of this document.....	6
2. Reference documents.....	6
3. Added value of Capacity Models.....	6
4. Capacity Model IT system.....	7
5. Capacity Model process.....	7
5.1. Stakeholders and Timeline	7
5.1.1. List of involved stakeholders and their role.....	7
5.1.2. Timeline for Capacity Model.....	8
5.2. Definition of Capacity Models	8
5.2.1. Start and input collection (X-36 to X-24).....	8
5.2.2. Construction/revision of draft Capacity Model (X-24 to X-21)	9
5.2.3. Finalisation of the Capacity Model (X-21 to X-18)	10
5.2.4. Capacity Partitioning (at X-18)	11
5.2.5. Extension of the Capacity Model (X-18 to X-11).....	11
6. Capacity Model content	11
6.1. Creation of the Capacity Models.....	12
6.1.1. Inclusion of the intended capacity usage line	12
6.1.2. Feeding of the Capacity Model.....	12
6.1.3. Generating the Capacity Models by ECMT	12
6.1.4. Cross-border sections	15
6.1.5. Verification of the uploaded information	15
6.1.6 Modification of the uploaded data.....	17
6.2. Traffic part of the model.....	18
6.3. Capacity Model variants	19
6.3.1. Standard non-TCR working day	20
6.3.2. Variants for particular periods	20
6.3.3. Variants for TCR / TCR window periods.....	21
6.4. Sources of input	25
6.5. Outputs.....	26
Annex A: Process diagram for Capacity Model	28
Annex B: Roadmap to Capacity Model.....	31
Annex C: Visualisation of Capacity Model.....	32
Annex D: Process for Capacity Needs Announcements.....	41
Annex E: Standardised template for Capacity Needs Announcements	43
Annex F: Capacity Model evaluation	48
Annex G: Calculation of intended capacity usage lines and unplanned capacities	49
Annex H: Process chart for creation of Capacity Model variants for TCR / TCR window periods ..	53
Annex I: Conflicting CNAs.....	55

Annex J: Changes in the submitted CNAs (differentiation between significant/not-significant changes)..... 56

Version history

VERSION	RESPONSIBLE	DATE	CHANGES
0.1	Sebastián Čarek Head of Sales & Capacity Process Management	2021-06-30	Creation of the initial version based on the "Description of the Timetabling and Capacity Redesign Process v2.00" and results of the Technical Workshop on CM, inclusion of remarks from the TTR project leaders
0.2	Sebastián Čarek Head of Sales & Capacity Process Management	2021-08-27	Remarks from the TTR Process Group incorporated.
0.3	Zsolt Ungvári Capacity Manager Ádám Kertai Head of Capacity Process Management	2021-09-17	Remarks from the TTR Process Group incorporated.
0.4	Zsolt Ungvári Capacity Manager Ádám Kertai Head of Capacity Process Management	2021-09-29	Remarks from the TTR Process Group incorporated.
0.5	Zsolt Ungvári Capacity Manager Ádám Kertai Head of Capacity Process Management	2021-10-20	Remarks from the Sales & Timetabling and Legal Matters Working Groups incorporated.
0.6	Zsolt Ungvári Capacity Manager Ádám Kertai Head of Capacity Process Management	2021-10-27	Remarks from the TTR Process Group and Legal Matters Working Group incorporated.
1.0	RNE General Assembly	2021-12-07	Approval of the version 0.6 by the RNE General Assembly on 7 December 2021
1.1	Zsolt Ungvári Capacity Manager	2022-03-03	Updated description of Capacity Needs Announcements
1.2	Zsolt Ungvári Capacity Manager	2022-03-16	Remarks from the TTR Process Group incorporated
1.3	Zsolt Ungvári Capacity Manager	2022-03-31	Remarks from the Legal Matters and Timetabling Working Groups incorporated.
2.0	RNE General Assembly	2022-05-31	Approval of the version 1.3 by the RNE General Assembly on 31 May 2022
2.1	Zsolt Ungvári Capacity Manager	To be confirmed	Updated description of Capacity Model variants
2.2	Zsolt Ungvári Capacity Manager	2022-06-01	Remarks from the TTR Process Group & TCR WG incorporated
2.3	Zsolt Ungvári Capacity Manager	2022-06-21	Remarks from the TTR Process Group & TCR WG incorporated
2.4	Zsolt Ungvári Capacity Manager	2022-10-13	Remarks from the Timetabling Working Group incorporated

Disclaimer, application and transition period

This document is intended as a handbook for the implementation of the so-called Capacity Model of the TTR Process as described by RNE. As neither legislation nor IT-systems are currently adapted to enable all the elements of TTR, individual TTR elements can only be implemented by the infrastructure managers to a limited extent for the upcoming timetable periods, starting in December 2024. If and when the legislation and IT-systems fully enable the implementation of all the elements of TTR, the different RNE handbooks on those elements should be applied to the process. The exact details for the transitional period are elaborated in the Basic Requirements.

Infrastructure Managers and Allocation Bodies should adapt their internal processes and the Network Statement in line with the Procedures for Capacity Models from X-36¹, where X denotes the first timetable referring to the complete rollout of TTR. The deadlines defined in sub-chapter 5.1.2 shall be applied after the complete roll-out of TTR Capacity Model.

The Basic Requirements contain the description of the geographical scope, which might be defined differently for the first years of implementation.

The Handbook contains elements referring to the period after X-18, these parts of the Handbook are subject of adjustments according to the future process development (e.g. Capacity Supply Handbook).

¹ Please note that the current version of the Handbook does not describe (yet) the final TTR target picture

1. Introduction and scope of this document

Essential part of the TTR process is the advanced planning. Based on the main planning principles for traffic and temporary capacity restrictions (TCRs), which are published in the Capacity Strategy, the Capacity Model is built. The main benefits obtained from a Capacity Model are firstly, the transparency in capacity usage, and secondly, the detection of potential capacity conflicts and congestions already at an early stage, giving more time to mitigate the situation with suitable measures.

This document describes the process by which Infrastructure Managers and Allocation Bodies (hereafter IMs) have to prepare the Capacity Models in line with the TTR principles. IMs shall follow these procedures in their entirety and harmonise their internal processes in order to promote internationally coordinated capacity management processes over the single European railway area.

2. Reference documents

This handbook follows and is based on the principles set out in the:

- **Description of the Timetabling and Capacity Redesign Process** version 3.0,² which includes further description and glossary of terms used in this document.
- **Procedures for Capacity Strategy** version 1.0³
- **Procedures for Temporary Capacity Restrictions** version 1.0⁴
- **Directive 2012/34/EU**, especially:
 - Article 38(2) on the prohibition to allocate paths beyond 1 TT period (exception framework agreements),
 - Article 39(1) on national frameworks for capacity allocation,
 - Article 40(1) on cooperation of IMs for efficient creation of infrastructure capacity,
 - Article 40(5) on assessing the need and organizing pre-arranged international train paths for freight trains,
 - Article 42 on framework agreements (with framework capacity allocation for 5 years),
 - Article 45 on Scheduling,
 - Article 46 on the coordination process,
 - Article 48(2) on reservation of capacity for foreseeable ad hoc requests,
 - Article 53 on infrastructure capacity for maintenance works,
 - Annex VII parts prescribing provisions about the TCR Planning and definition of provisional international train paths.
- **Commission implementing regulation (EU) 2016/545 on framework agreements**
- **Regulation 913/2010**, especially:
 - Article 14(3) and (5) on pre-arranged paths and reserve capacity.

3. Added value of Capacity Models

Supports the harmonisation of the cross-border capacity planning,
 Provides an overview on the available capacities on a European scale,
 Provides an overview concerning the infrastructure sections where possible future capacity bottlenecks can occur,
 Enables the unified clustering of TCRs,
 Enables the unified impact calculation of TCRs,
 Facilitates the consultation on traffic solutions during TCR periods with providing a standardised, transparent platform for every involved stakeholder,

² Accessible via: https://cms.rne.eu/system/files/long_description_of_the_ttr_process_v3.0_2021-12-07_0.pdf

³ Accessible via: https://cms.rne.eu/system/files/hb_capacity_strategy_1.0_2021-12-07_2.pdf

⁴ Accessible via: https://cms.rne.eu/system/files/hb_tcr_1.0_2021-12-07_2.pdf

Provides a good base to implement smart functionalities in the future (optimisation etc.).

4. Capacity Model IT system

RailNetEurope provides the European Capacity Management Tool ([ECMT](#)), which shall be used for the submission of Capacity Needs Announcements, international coordination, publication and consultation of Capacity Models⁵.

The ECMT has to support both the Applicants and IMs in carrying forward the CNAs and Capacity Models from one timetable period to another, with possibility to adjust them according to new capacity needs.

5. Capacity Model process

This process defines the stakeholders, which are involved in the capacity modelling, timeline to be followed by IMs and process steps that should be executed during the particular sub-phases of the Capacity Model phase.

5.1. Stakeholders and Timeline

5.1.1. List of involved stakeholders and their role

Stakeholder	Roles and involvement
Applicant	<p>A railway undertaking or an international grouping of railway undertakings or other persons or legal entities, such as competent authorities under Regulation (EC) No 1370/2007 and shippers, freight forwarders and combined transport operators, with a public-service or commercial interest in procuring infrastructure capacity.</p> <p>In line with the above definition the possible Applicants are the following:</p> <ul style="list-style-type: none"> RU Applicants: A railway undertaking (RU) or an international grouping of railway undertakings. Non-RU Applicants (for example): <ul style="list-style-type: none"> Competent authority (e.g. national/local MoT, etc.) Shippers / Freight forwarders
IM	Infrastructure Manager (or Allocation Body) in charge of the Capacity Model.
International Leading Entity	Definition shall be aligned to the results of discussion on the International Leading Entity.
International Supporting Entity	<p>Besides the provision of tools for supporting cross border alignment the International Supporting Entity facilitates the conflict resolution process and can contribute to the activities of national/international decision-makers, if necessary.</p> <p>The <i>service provider</i> role is realised with the operation of RNE IT-tools.</p> <p>Concerning the <i>monitoring, process developments and proposing recommendation</i> roles two RNE bodies are involved:</p> <ul style="list-style-type: none"> • Capacity Management Advisory Group (platform for IM-RU exchange) • RNE Advance Capacity Planning Working Group (IM WG to be established)

⁵ Please note that the exact visualisations in the IT-tool can differ from the figures which are shown in this Handbook

Involved IMs	Infrastructure Manager (or Allocation Body) that is or might be concerned in or affected by the particular Capacity Model.
Other involved stakeholders	The organisation, which might be involved into the Capacity Model process: <ul style="list-style-type: none"> • National and local infrastructure funds • Transport associations and transport organisers • Relevant supranational institutions
Operator of service facility	Any public or private entity responsible for managing one or more service facilities or supplying one or more services to railway undertakings referred to in points 2 to 4 of Annex II of Directive 2012/34/EU of the European Parliament and of the Council.

5.1.2. Timeline for Capacity Model

The following table shows the main milestones in the Capacity Model phase⁶.

Timeline	Milestone/Action
X-36	Start of the Capacity Model phase
X-26	IMs invite the Applicants to submit CNAs
X-24	Deadline to submit the Capacity Needs Announcements
X-23	The Applicants, who submitted CNA(s) are notified about the result of the analysis of the IMs (Acknowledged/To be updated/Not (fully) considered)
X-22.5	If the IMs ask for additional information on the CNA, then the concerned Applicants shall send the requested set of information to the IMs
X-22	The IMs conclude which CNAs will be taken into account during the creation of draft Capacity Models (Acknowledged/Not considered)
X-21	Deadline to publish draft Capacity Models. The Capacity Models are accessible for all Applicants
X-18	Deadline to publish final Capacity Models
X-12 ^{4,7}	Deadline to publish the draft of extended Capacity Models (inclusion of volumes planned after X-18 e.g. additional ad hoc volumes)
X-11 ^{4,5}	Deadline to publish the final version of the extended Capacity Models

5.2. Definition of Capacity Models

5.2.1. Start and input collection (X-36 to X-24)

At X-36, IMs start the work on Capacity Models in line with the framework published in the respective Capacity Strategy, namely in its chapter 3: Traffic planning principles and traffic flows.

The initial Capacity Models shall consider the information already available at IMs (e.g. Capacity Models of previous timetable years, studies, own forecasts). Furthermore, the neighbouring IMs shall

⁶ After the full implementation of TTR the Capacity Model timeline will end at X-18, therefore, the Capacity Model extensions will be phased out and the preparation of Capacity Supply will begin at the same time.

⁷ In case the final Capacity Model (published at X-18) reflects to the business needs properly, then the creation of extended versions is not mandatory.

be contacted to exchange information regarding the possible developments at borders, and preliminary optional discussions can be also conducted with Applicants to collect additional information on market needs.

The gathered already available information on future traffic needs on IM-side can be enriched based on the CNAs, therefore, at X-26 the IMs invite the Applicants to submit CNAs via the ECMT-tool. The aim of the CNAs is to contribute to the more precise long-term planning of volumes by providing additional information on the future needs, and to facilitate the identification of capacity bottlenecks at an early stage. In this way the Applicants can contribute to the identification of the pressuring points, where the level of service should be increased or is subject to change. The Applicants should consider their right to submit CNAs, and they are actively asked to do so for new/adjusted capacity needs, but they might also communicate the status quo expectations. In order to ensure the implementation of discrimination free processes, it has to be highlighted, that the submission of CNAs does not mean any kind of pre-booking at later Capacity Management stages and can be considered just as an additional information source on future business needs to the long-term planning activities of IMs.

If IMs conduct the preliminary consultation of certain Major and High impact TCRs with Applicants until X-26 and provide them sufficient information and data to study rerouting scenarios at this stage, then IMs can ask Applicants to submit CNAs accordingly. After the publication/notification the IMs shall not make significant changes⁸ in TCRs without consulting them with the Applicants in advance.

By X-24, all Applicants can submit Capacity Needs Announcements in a standardised format (see Annex E), which shall be used in all networks. CNAs are regularly exchanged and discussed between the concerned IMs. Further details about CNAs can be found in Annex D.

5.2.2. Construction/revision of draft Capacity Model (X-24 to X-21)

Between X-24 and X-21, IMs analyse the collected input from different sources (e.g. CNAs, studies), and create the draft Capacity Models.

After X-24 the IMs start to analyse the submitted CNAs, then at X-23 the Applicants are notified about the result of the analysis, which can be the following:

1. Acknowledged: The submitted CNA will be taken into consideration during the creation of the draft Capacity Model.
2. To be updated: The IMs need further information from Applicants.
3. Not (fully) considered: The IMs are not in the position to take into account the CNA during the creation of draft Capacity Model. In each case the reasons shall be provided by the IMs and shall be stored in ECMT. The consultation will follow as described below.

Between X-23 and X-22 the CNAs, which were not fully considered by the IMs, shall be consulted between the concerned IMs and Applicants in order to find suitable market-oriented solutions for their business needs. In case the IMs need further information regarding a CNA they can officially invite the Applicants to provide more information to the CNA. The Applicants shall answer as soon as possible, but not later than in 2 weeks. Further iterative dialogues should be organised for conflicting CNA and concerned Applicants to find good market-orientated solutions in line with the developed harmonised allocations principles taking into consideration confidentiality on the case-by-case-basis. Moreover, KPIs should be developed and agreed between IMs and Applicants to monitor the behaviour of both parties.

By X-22 the IMs conclude which CNAs will be taken into account during the creation of draft Capacity Models. This conclusion refers only to the draft Capacity Model, it does not guarantee that all acknowledged CNAs will be included into the final Capacity Model as volumes, since there might be

⁸ The list of changes, which shall be considered as significant ones can be found in Annex J of Procedures for Temporary Capacity Restriction Management

capacity conflicts to be tackled during the consultation of the draft Capacity Models. Furthermore, the incorporation of an acknowledged CNA into the final Capacity Model does not automatically mean that the parameters indicated in the CNA will be included in the Capacity Supply as provided by the Applicant. Further details shall be incorporated into the "Procedures on Capacity Supply".

The final goal of TTR is the European-wide sectoral harmonisation, therefore, the IMs should avoid incorporation of partial CNAs⁹ into the draft Capacity Model. In cases when one of the IMs is not able to consider an internationally relevant CNA, the Applicants shall be given the opportunity to update the CNA (for instance exclude the territory/withdraw the CNA).

The Applicants will have the possibility to upload additional information to the CNA through the whole period (X-24 – X-21), but in case of significant changes the IMs may not consider the modified CNAs during the creation of the draft Capacity Models. The description of significant and not-significant changes can be found in Annex J. For the draft Capacity Model variants for TCR periods this provision does not apply, and Applicants are able to make even significant changes in submitted CNAs without the risk of exclusion if these updates are results of conducted TCR consultations and in line with the agreement made with the IMs.

In this period (X-24 – X-21) Applicants can be contacted by IMs in case any clarification is needed. IMs perform plausibility check of data, attempt to detect multiple data entries for the same traffic demand and try to compare the external input with own traffic forecast hypothesis.

The volumes should be harmonised at cross-border sections, therefore, the IMs shall prepare together the draft Capacity Models of these sections in this period. The harmonisation shall be coordinated by one of the concerned IMs (responsibilities should be set in the Capacity Strategies for each border section). The two neighbouring IMs confirm each other the validity of the respective national models before publishing the draft Capacity Models.

Considering the possible changes in the final capacity needs, it is possible to create alternative variants of the Capacity Models for the same period, if needed. As a general rule, the Capacity Models of the border sections shall contain one version, any other solution should be agreed upon by all involved IMs.

During the preparation of the first versions of the Capacity Model variants, it should be taken into consideration that the TCR consultation is an iterative process, therefore, the capacity consumption should be aligned to the updated information on the TCRs.

At X-21, IMs publish the draft versions of the internationally coordinated Capacity Models. In order to ensure the transparent and non-discriminatory treatment of all applicants, and to be able to fully utilise the benefits of the Capacity Models, the draft and final Capacity Models shall be made available and accessible in digital format for each potential Applicant (e.g. in RNE ECMT).

5.2.3. Finalisation of the Capacity Model (X-21 to X-18)

Between X-21 and X-18, IMs consult Applicants of whose capacity needs cannot be fully considered in the Capacity Models and try to find alternative solutions. The CNAs should be incorporated in the Capacity Model in a continuous way to connect the origin, commercial stops and destination. Further iterative dialogues must be organised for conflicting CNAs to find good market-orientated solutions in line with the developed harmonised allocations principles taking into consideration confidentiality on the case-by-case-basis. During this sub-phase, any reported inconsistency has to be removed

⁹ Partial CNA means that the concerned IMs came to different conclusions on a submitted CNA, e.g., a CNA was submitted for a volume from the network of IM "A" to IM "C" via IM "B". IM "B" does not consider the CNA in the draft CM but IM "A" and "C" yes. In these cases, the Applicants shall be invited to choose the next steps (keep the CNA regarding IM "A" and/or "C" or withdraw the whole CNA).

and the Capacity Models fine-tuned and finalised. The final Capacity Models shall be coordinated and internationally harmonised.

5.2.4. Capacity Partitioning (at X-18)

At X-18, IMs perform the so-called "capacity partitioning" within the Capacity Model, it can also be understood as the publication of the final Capacity Model. By applying this capacity partitioning procedure, the capacity of a railway line section is set aside in the Capacity Model for dedicated purposes:

- Volumes for passenger traffic,
- Volumes for freight traffic,
- Temporary Capacity Restrictions.

It should be ensured that high-quality capacity products will be set aside for both market segments (passenger and freight).

The partitioning shall be set at least for the whole timetable period and for the traffic volumes for a standard non-TCR weekday. It is up to the IMs to perform more detailed capacity partitioning where needed, this partitioning can differentiate capacity from product point of view:

- Annual timetable volumes for both passenger and freight,
- Rolling Planning volumes (covering also multi-annual needs),
- Ad hoc volumes,
- Unplanned capacity (usable later for any volumes above).

The IMs must consider the business needs while they are making decision on the application of detailed capacity partitioning.

The access to the final Capacity Models shall be ensured to all Applicants, therefore, a link to a particular IT tool (e.g. RNE ECMT) shall be included on the website of the IM.

The IMs must set up joint procedures for cases when an agreement with the involved stakeholders cannot be reached even after iterative consultation. This might consist of the congestion declaration and/or the application of allocation principles to priorities certain traffic volumes. The procedures shall be published in the Network Statement.

5.2.5. Extension of the Capacity Model (X-18 to X-11)

If there is a need for adjusting the published Capacity Models due to changed business needs or updated information on traffic needs during TCR periods, the Capacity Models can be extended. The draft version of the extended Capacity Models shall be published at X-12. The changes in the Capacity Model are consulted with the Applicants, which are affected with these adaptations. If an amendment has effects on the Capacity Models of neighbouring IMs, then these changes have to be coordinated, as well.

The final version of the extended Capacity Models shall be published at X-11.

After the full implementation of TTR the Capacity Model lifecycle will end at X-18 with the publication of the final Capacity Models. Therefore, point 5.2.5. will have to be revised, accordingly.

6. Capacity Model content

This chapter provides an overview on the Capacity Model content, which consists of a 24-hour overview reflecting market needs (traffic part) and in case of variants for TCR periods on the capacity consumed by TCRs. Furthermore, the input sources to be used in the construction of the Capacity Models are described as well as the outputs at different milestones.

6.1. Creation of the Capacity Models

The creation of the Capacity Models can be divided into three phases.

6.1.1. Inclusion of the intended capacity usage line

The Capacity Model contains the intended capacity usage line, which indicates the maximum number of volumes, which can be accommodated without paying special attention to capacity planning / extraordinary traffic management measures (examples for counting this value can be found in Annex G).

The intended capacity usage line has to be defined for every railway line (it will be also possible to define different intended capacity usage lines for a railway line e.g. in case of the usage of different Capacity Model variants).

The aim of the calculation of the intended capacity line on one hand is to provide a clear picture on the planned capacity situation and to detect the pressuring points, where the IMs have to make additional efforts to ensure the stability of the timetable. On the other hand, the IMs and applicants will have a clear picture on the number of unplanned capacities, which would be available for the ad hoc requests during the concerned timetable period.

In order to guarantee the stability/robustness of a timetable, an IM plans a certain number of paths. Due to increased capacity requirements at certain hours (e.g., rush hour), an IM can selectively raise the intended capacity usage line. This leads to an increased risk that punctuality will suffer in the event of minor irregularities. In order for the timetable system to recover, it is important that after a temporary increase in the number of paths, the number of possible paths is reduced to the standard value.

The ECMT shall automatically indicate if one volume goes above the intended capacity usage line and it should open the Capacity Model, which needs to be checked. It is possible to create Capacity Models containing planned objects above the intended capacity usage line, but in order to provide a stability of the timetables it is recommended to try to avoid these situations as far as possible.

6.1.2. Feeding of the Capacity Model

The time data of the volumes should be uploaded into the ECMT on Primary Location Code (PLC)¹⁰ level for each railway line. The input should determine at least one time data per railway line (given that there are two major hubs and between them two parallel lines (e.g. one high-speed and one conventional)), so the time data should refer to the planned line. The template of the Capacity Model import sheet can be found in Annex E.

6.1.3. Generating the Capacity Models by ECMT

In practice, the Capacity Models are not pre-defined, the tool can create them based on the needs of the users. The Capacity Models can be generated in three different formats¹¹:

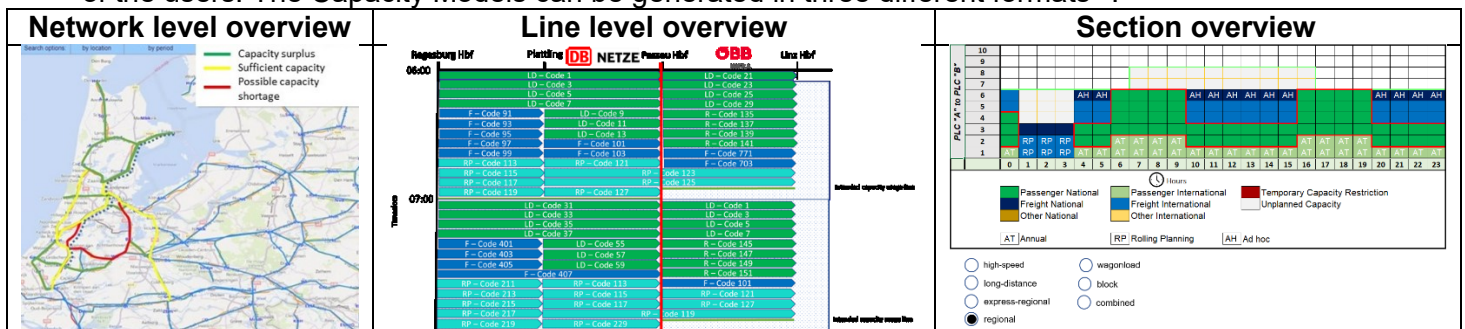

¹⁰ Primary Location Code (PLC) as defined by TAF TSI Standard

¹¹ The exact visualisation of overviews can differ from these examples

General overview on capacity on a very high level (e.g. capacity situation of a selected country)	Capacity situation on a selected line to facilitate the cross-border harmonisation and creation of variants (e.g. during TCR periods)	Capacity situation between two PLCs (e.g. to gather information on the planned volumes for a border section)
Mostly used by higher management levels, Ministry of Transport, etc.	Mostly used by IMs, Applicants	Mostly used by Applicants

The generated Capacity Model analyses only the situation at the starting point, so the duration of the occupation of the volumes will not be considered in the Capacity Model.

The below explanation provides an additional illustration to facilitate the proper elaboration of the Capacity Models using the section overview.

Explanation:

- Railway line between A – C (via B)
- Direction A → C
- Additional points can be added (based on PLCs)
- High-speed passenger train travel time from A to C: 45 min
- ATT Freight train travel time from A to C: 120 min
- Regional passenger train travel time from B to C: 60 min

The Capacity Model visualises the values, which are valid at the first planning point (PLC). In case the model is generated for the volumes from point A to C, then it takes into account the time data, which is available at point A. Therefore, the volumes from point B towards point C will not be considered during the generation of the Capacity Model between the points A and C.

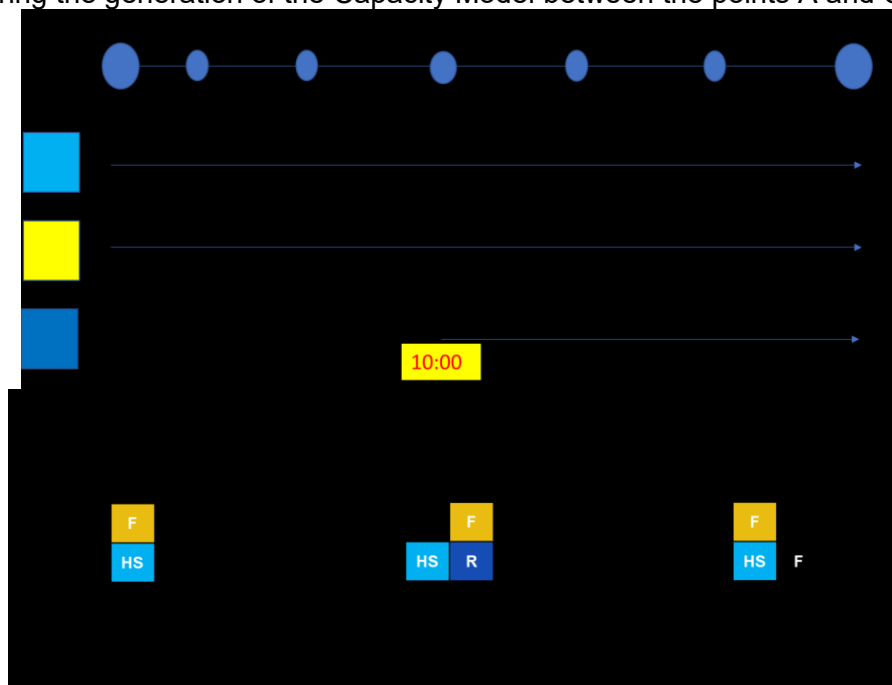

For TCR consultation purposes the IMs can either utilise the PLC-based railway line overview (please see point 6.1.5) or use the section overview of Capacity Models. In the latter case the IMs should determine the point of the split, where significant timetable or traffic operation differences occur, such as beginning or ending services, different number of trains, train mixture and/or train sequence.

Further descriptions of the visualisation possibilities can be found in Annex C. Taking into account that the IMs have the possibility to upload different information on traffic volumes for different periods it shall be possible to indicate in ECMT for which day/period the Capacity Model should be generated.

The below calendar displays the case, when the IM defined the following variants for the TT period for a section of a railway line¹².

- Non-TCR standard day (green) – (has to be prepared on a mandatory basis)
- Variant for the last working day of the week in school periods (light green)
- Variant for weekends (blue)
- Variant for weekdays during school holidays (yellow)
- Variants for Major and High impact TCRs (red) (have to be prepared on a mandatory basis)



¹² The variants besides the mandatory ones ("Non-TCR standard day" and "Variants for Major and High impact TCRs") are listed as examples, additional variants can be defined freely by the IMs based on the needs.

2024		MON	TUE	WED	THU	FRI	SAT	SUN	WEEK												
CAPACITY MODEL - CALENDAR VIEW - TT2024 RAILWAY LINE Dresden Hbf --> Berlin Hbf, SECTION Dresden Hbf --> Elsterwerda																					
										MON	TUE	WED	THU	FRI	SAT	SUN	WEEK				
JAN									52	JUL											
		1	2	3	4	5	6	7	1		1	2	3	4	5	6	7	27			
		8	9	10	11	12	13	14	2		8	9	10	11	12	13	14	28			
		15	16	17	18	19	20	21	3		15	16	17	18	19	20	21	29			
		22	23	24	25	26	27	28	4		22	23	24	25	26	27	28	30			
		29	30	31					5		29	30	31					31			
FEB										AUG											
					1	2	3	4	5					1	2	3	4	31			
		5	6	7	8	9	10	11	6		5	6	7	8	9	10	11	32			
		12	13	14	15	16	17	18	7		12	13	14	15	16	17	18	33			
		19	20	21	22	23	24	25	8		19	20	21	22	23	24	25	34			
		26	27	28	29				9		26	27	28	29	30	31		35			
MAR						1	2	3	9	SEP											
		4	5	6	7	8	9	10	10		2	3	4	5	6	7	8	35			
		11	12	13	14	15	16	17	11		9	10	11	12	13	14	15	36			
		18	19	20	21	22	23	24	12		16	17	18	19	20	21	22	37			
		25	26	27	28	29	30	31	13		23	24	25	26	27	28	29	38			
											30							39			
																		40			
APR										OCT											
		1	2	3	4	5	6	7	14			1	2	3	4	5	6	40			
		8	9	10	11	12	13	14	15		7	8	9	10	11	12	13	41			
		15	16	17	18	19	20	21	16		14	15	16	17	18	19	20	42			
		22	23	24	25	26	27	28	17		21	22	23	24	25	26	27	43			
		29	30						18		28	29	30	31				44			
MAY										NOV											
				1	2	3	4	5	18					1	2	3		44			
		6	7	8	9	10	11	12	19		4	5	6	7	8	9	10	45			
		13	14	15	16	17	18	19	20		11	12	13	14	15	16	17	46			
		20	21	22	23	24	25	26	21		18	19	20	21	22	23	24	47			
		27	28	29	30	31			22		25	26	27	28	29	30		48			
JUN										DEC											
						1	2		22												
		3	4	5	6	7	8	9	23		2	3	4	5	6	7	8	48			
		10	11	12	13	14	15	16	24		9	10	11	12	13	14	15	49			
		17	18	19	20	21	22	23	25		16	17	18	19	20	21	22	50			
		24	25	26	27	28	29	30	26		23	24	25	26	27	28	29	51			
											30	31						52			
																		1			

Capacity Model variant

- Non-TCR standard day for TT2024
- Variant for the last working day of the week in school periods for TT2024
- Weekend variant for TT2024
- School holiday variant for weekdays for TT2024
- Variant for Major impact TCR for TT2024
- Variant for High impact TCR for TT2024

6.1.4. Cross-border sections

Cross-border sections shall be defined as separate line sections. The volumes published in neighbouring sections have to be aligned to ensure seamless capacity product construction and train operation in the later stages. The IMs agree, which of them is coordinating the creation of the draft/final/extended Capacity Model for the cross-border section. The outputs and granularity of cross-border Capacity Models shall be in line with the requirements defined by point 6.5. The responsibilities should be set by the Capacity Strategies for each border section.

6.1.5. Verification of the uploaded information

The IMs should have the possibility to check the correctness of the uploaded information, therefore these verification tasks shall be also supported by ECMT. To fulfil this need, ECMT will be able to generate overviews on the railway lines based on the data, which was uploaded by the IMs regarding the concerned PLCs. The example on the possible visualisation of line level overviews can be found below:

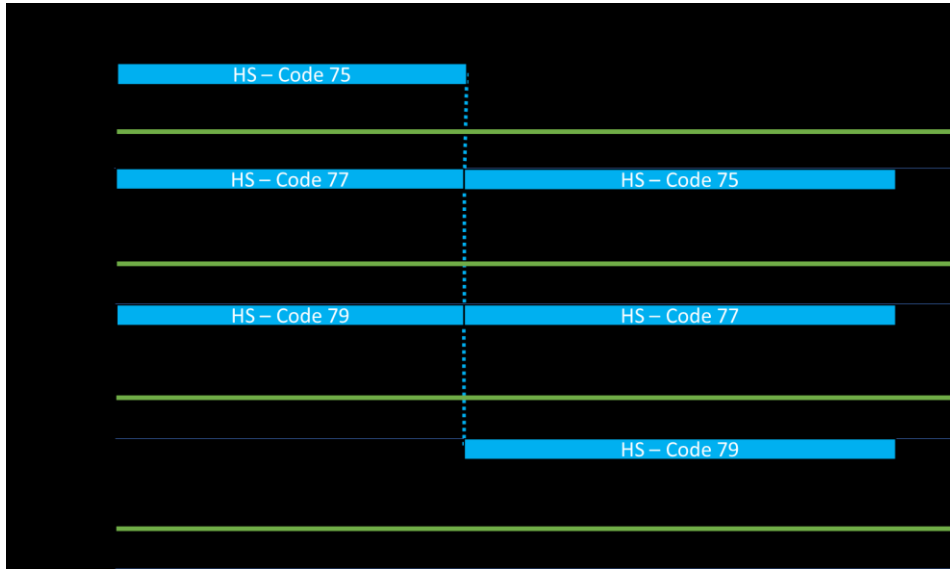

Verification of the uploaded information – Example 1

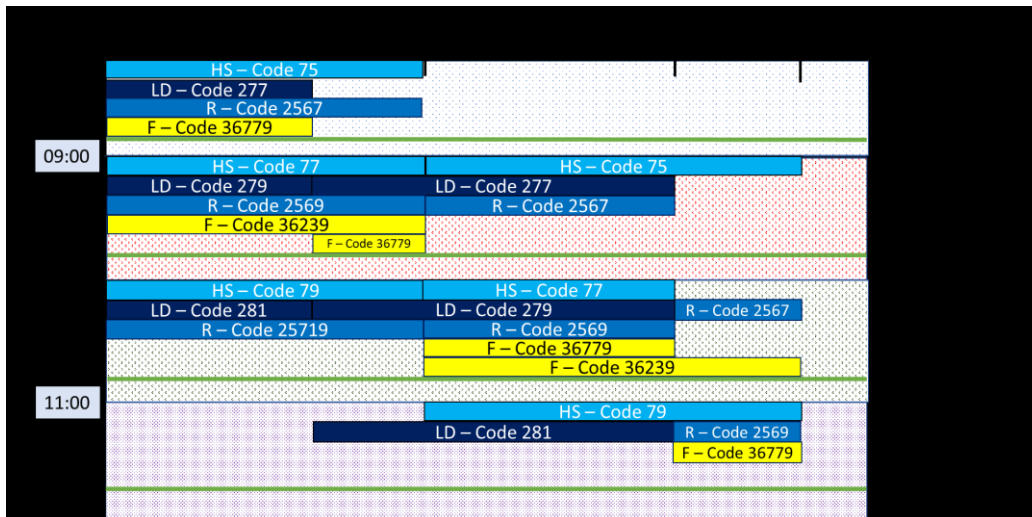

Verification of the uploaded information – Example 2

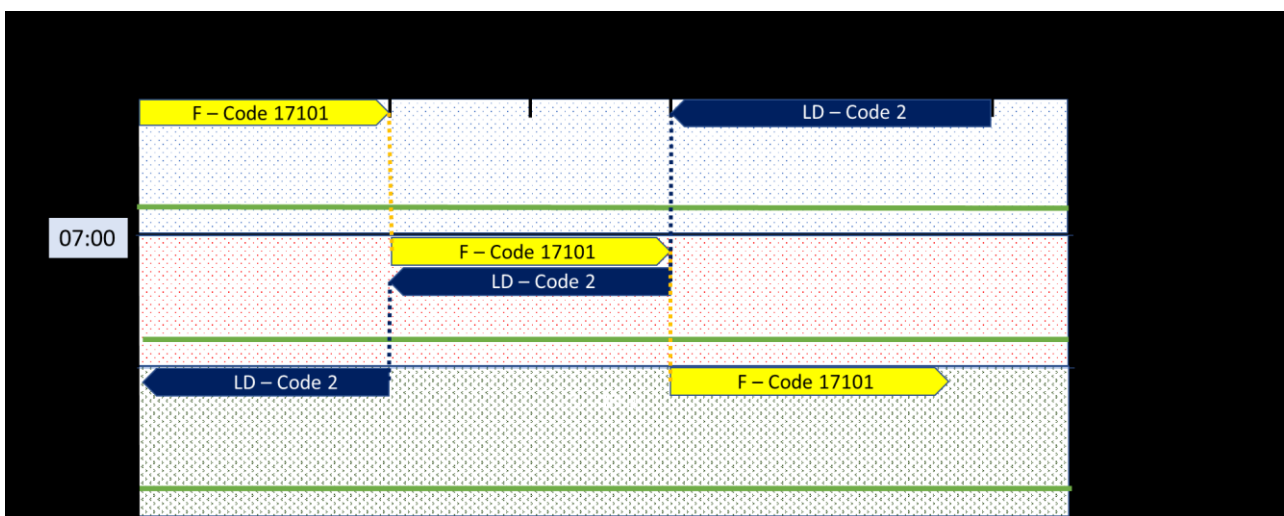

Verification of the uploaded information – Example 3 (single track line)

The line level overview can be utilised also for cross-border harmonisation and TCR-consultation purposes.

6.1.6. Modification of the uploaded data

The preparation of the Capacity Model contains several updating periods, therefore, the ECMT shall support the smooth modification of the previously uploaded information possibly with easy-to-use solutions:

1. By clicking on the volume, the background figures appear, the database can be modified directly, and the visualisation shall be aligned to the new data by ECMT automatically.

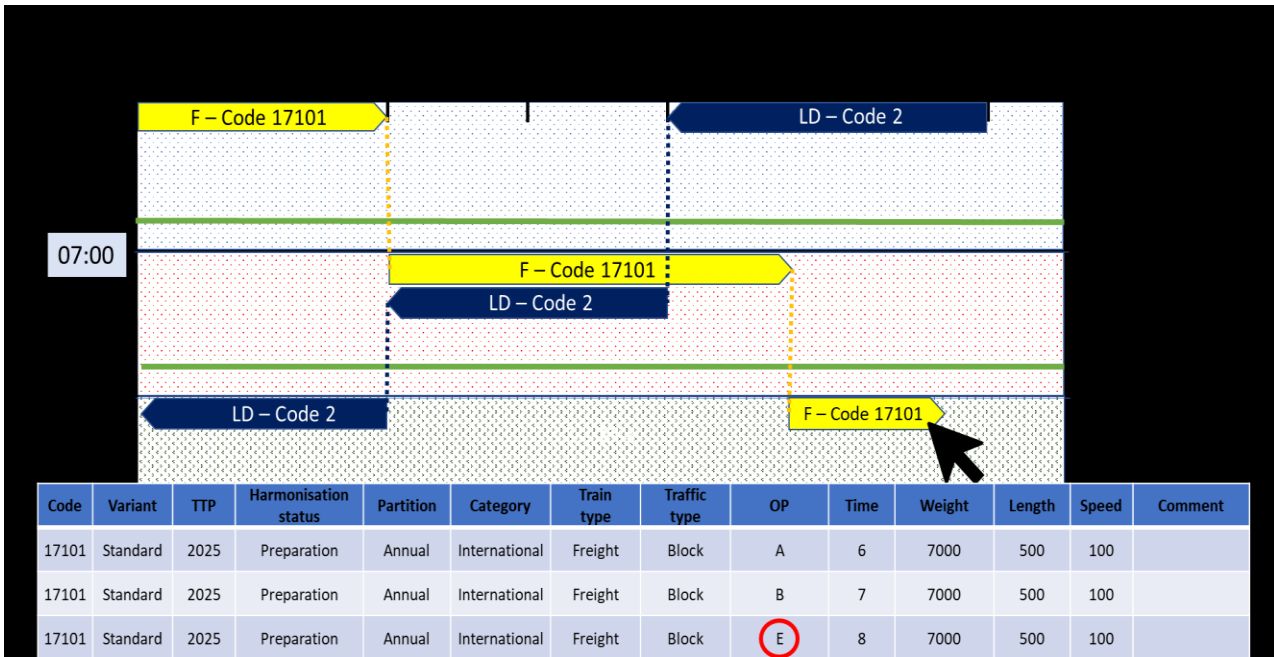

- By moving the volumes directly in the graphical layer and ECMT shall make the necessary changes in the database, accordingly.

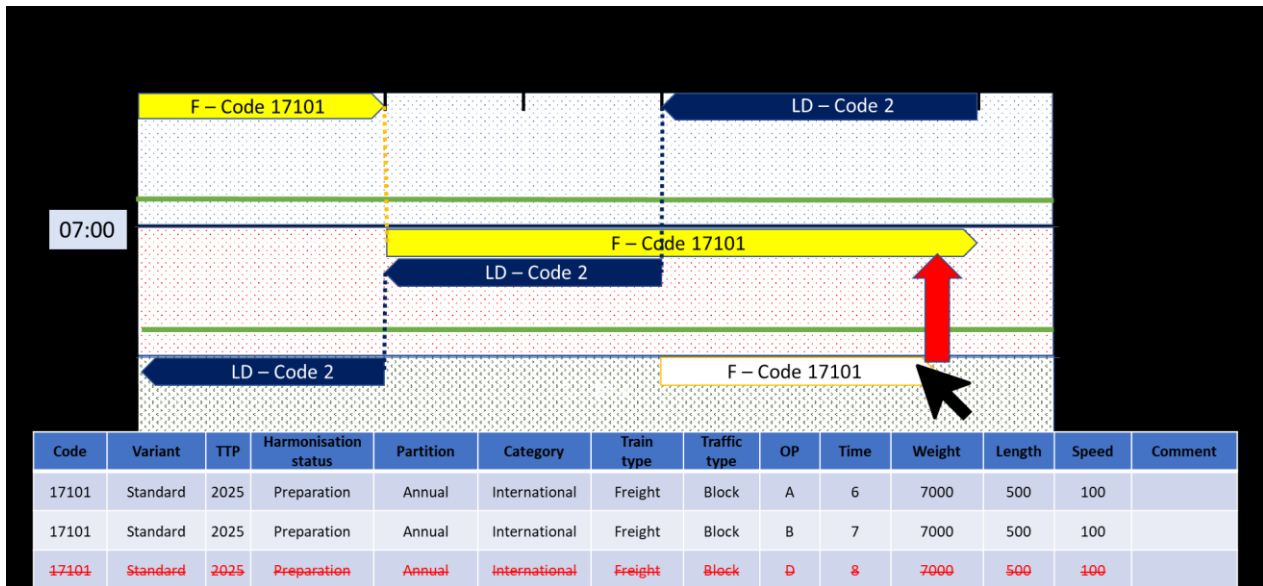

6.2. Traffic part of the model

The aim of the traffic part of the Capacity Model is to show, harmonise and discuss more in detail the expected volumes of capacity consumed by each commercial market segment. IMs might first prepare a reference hour overview, which is developed into a 24-hour time-space capacity diagram. The traffic part of the model displays for each railway line per direction¹³ the following objects, accompanied by a set of parameters that are important to identify the capacity consumption. For the sake of confidentiality, not all parameters could always be publicly accessible in the Capacity Model. The visualisation examples can be found in Annex C.

The following layers have been identified regarding the Capacity Models:

1. Layer	2. Layer	3. Layer	4. Layer	5. Layer ¹⁴
<ul style="list-style-type: none"> • Passenger • Freight/ • Other (loco train etc.) • TCR 	<ul style="list-style-type: none"> • International • National 	Basic categories for passenger trains: <ul style="list-style-type: none"> » high-speed trains » long-distance trains » express regional trains » regional trains 	Basic parameters for passenger trains: <ul style="list-style-type: none"> stopping pattern (according to point 5.1) acceleration(m/s²) planned speed maximum train length Basic parameters for freight trains:	Products: <ul style="list-style-type: none"> » Annual Timetable request » Rolling Planning request » Ad-hoc volumes¹⁶ » Unplanned capacities¹⁷

¹³ At a later stage in case of single-track sections it will be possible to generate one Capacity Model for both directions.

¹⁴ The table is subject of adjustments based on the experience on the implementation of TTR along with the preparation of the Rolling Planning Handbook.

¹⁶ On networks with an increased volume of ad hoc traffic, i.e., capacity requirements that cannot be planned in advance, capacity can also be partitioned for this kind of traffic.

¹⁷ There might be some capacity left on a line. Depending on the usage of a line, this unplanned capacity can vary between ‘nothing’ and ‘a lot of’ – it can be displayed in the form of empty rows in the space in the diagram, or with colours on the network map. The methods of calculation of unplanned capacities can be found in Annex G.

		<p>Basic categories for freight trains:</p> <ul style="list-style-type: none"> » wagonload » block » combined transport train (optional). <p>Categories in cross-border line sections must be harmonised (preferably already in the strategy phase).</p>	<ul style="list-style-type: none"> average maximum standard train weight, » average maximum standard train length, » expected speed¹⁵, » dangerous goods or extraordinary consignments (allowed or not), profile. <p>IMs should keep only the above basic parameters and avoid using additional ones if they are not entirely necessary.</p> <p>In the Capacity Strategy the parameters of the basic categories should be defined. The parameters of the basic categories can vary between the different railway lines.</p> <p>The same volume can belong to different categories during the train run (A → B, long-distance passenger, B → C high-speed passenger).</p>	
--	--	---	---	--

Layers No 1 and 2 shall be filled on an obligatory basis, layers No 3, 4 and 5 can be filled voluntarily by the IMs. The filling of the optional layers is independent of each other, e.g. filling No 3 and 4 is not the prerequisite of the filling of No 5.

Furthermore, in case of a regular TCR window, or a particular TCR (if a Capacity Model variant was created for a specific TCR period) occupies a certain amount of capacity – it should be displayed in the 24h overview as TCR window/particular TCR.

6.3. Capacity Model variants

The IMs shall define for each day of the TT period, which Capacity Model variant should be considered during the generation of the Model in ECMT. In practice, it can mean that one variant is applicable on all days and theoretically it shall be also possible to set different Capacity Model variants for each day. The process steps regarding the definition of Capacity Models can be found in point 5.2.

¹⁵ Defined by the IM. An applicant can submit certain parameters via CNAs, but the IM has to have the right to modify them if this would lead to better utilisation of capacity.

Basically, the below Capacity Model variants can be constructed and published for a particular TT period:¹⁸

- Standard non-TCR working day (mandatory)
- Variants for particular periods such as different days of the week, school days, weekends, summer/winter holidays etc (optional)
- Variants for particular TCR periods to provide an overview on the traffic flows during a specific TCR (mandatory for Major and High impact TCRs)
- Variants for TCR window periods (highly recommended)

6.3.1. Standard non-TCR working day

As minimum requirement the IMs shall define at least one standard non-TCR Capacity Model variant for the TT period, which then will be used during the generation of Capacity Models. The IMs shall strive to define this variant based on a working day, which represents the standard traffic situation as far as possible. The below calendar displays the minimum case, when the IM defined one Capacity Model variant for the whole TT period for a section of a railway line.

2024		MON	TUE	WED	THU	FRI	SAT	SUN	WEEK	MON	TUE	WED	THU	FRI	SAT	SUN	WEEK	
 CAPACITY MODEL - CALENDAR VIEW - TT2024 RAILWAY LINE Dresden Hbf --> Berlin Hbf, SECTION Dresden Hbf --> Elsterwerda																		
JAN		1	2	3	4	5	6	7	52	JUL	1	2	3	4	5	6	7	27
		8	9	10	11	12	13	14	1		8	9	10	11	12	13	14	28
		15	16	17	18	19	20	21	2		15	16	17	18	19	20	21	29
		22	23	24	25	26	27	28	3		22	23	24	25	26	27	28	30
		29	30	31					4		29	30	31					31
FEB					1	2	3	4	5	AUG				1	2	3	4	31
		5	6	7	8	9	10	11	6		5	6	7	8	9	10	11	32
		12	13	14	15	16	17	18	7		12	13	14	15	16	17	18	33
		19	20	21	22	23	24	25	8		19	20	21	22	23	24	25	34
		26	27	28	29				9		26	27	28	29	30	31		35
MAR					1	2	3		9	SEP							1	35
		4	5	6	7	8	9	10	10		2	3	4	5	6	7	8	36
		11	12	13	14	15	16	17	11		9	10	11	12	13	14	15	37
		18	19	20	21	22	23	24	12		16	17	18	19	20	21	22	38
		25	26	27	28	29	30	31	13		23	24	25	26	27	28	29	39
											30							40
APR		1	2	3	4	5	6	7	14	OCT		1	2	3	4	5	6	40
		8	9	10	11	12	13	14	15		7	8	9	10	11	12	13	41
		15	16	17	18	19	20	21	16		14	15	16	17	18	19	20	42
		22	23	24	25	26	27	28	17		21	22	23	24	25	26	27	43
		29	30						18		28	29	30	31				44
MAY				1	2	3	4	5	18	NOV					1	2	3	44
		6	7	8	9	10	11	12	19		4	5	6	7	8	9	10	45
		13	14	15	16	17	18	19	20		11	12	13	14	15	16	17	46
		20	21	22	23	24	25	26	21		18	19	20	21	22	23	24	47
		27	28	29	30	31			22		25	26	27	28	29	30		48
JUN					1	2			22	DEC							1	48
		3	4	5	6	7	8	9	23		2	3	4	5	6	7	8	49
		10	11	12	13	14	15	16	24		9	10	11	12	13	14	15	50
		17	18	19	20	21	22	23	25		16	17	18	19	20	21	22	51
		24	25	26	27	28	29	30	26		23	24	25	26	27	28	29	52
											30	31						1

Capacity Model variant
Non-TCR standard day for TT2024

15 December 00:01 Start of the timetable 2025

6.3.2. Variants for particular periods

The IMs shall have the possibility to define further Capacity Model variants in order to better reflect to the different traffic situations of various periods. The variants can cover the changing traffic needs of particular days of a week (e.g. additional needs on Fridays), weekends (e.g. increased needs due

¹⁸ For cross-border sections the periods have to be aligned.

to tourists), or even school holidays (winter/summer). The definition of additional variants can be restricted to limited geographical scope and can be relevant to the whole network, as well.

However, it will be up to the IMs to create additional Capacity Model variants, the decision-making should consider on one hand the business trends (own forecasts, information received via CNAs) and on other hand also the available resources (HR, IT).

It can be assumed that after the first years of the complete roll-out of TTR, the IMs will create more and more variants to further utilise the added values of Capacity Models and continue the development of their long-term capacity planning activities.

The below calendar displays the case, when the IM defined the following variants for the TT period for a selected section of a railway line:

- Non-TCR standard day (green)
- Variant for weekends (blue)
- Variant for weekdays during school holidays (yellow)

2024		MON	TUE	WED	THU	FRI	SAT	SUN	WEEK	MON	TUE	WED	THU	FRI	SAT	SUN	WEEK	
 CAPACITY MODEL - CALENDAR VIEW - TT2024 RAILWAY LINE Dresden Hbf --> Berlin Hbf, SECTION Dresden Hbf --> Elsterwerda																		
JAN		1	2	3	4	5	6	7	52	JUL	1	2	3	4	5	6	7	27
		8	9	10	11	12	13	14	1		8	9	10	11	12	13	14	28
		15	16	17	18	19	20	21	2		15	16	17	18	19	20	21	29
		22	23	24	25	26	27	28	3		22	23	24	25	26	27	28	30
		29	30	31					4		29	30	31					31
FEB					1	2	3	4	5	AUG	5	6	7	8	9	10	11	31
		5	6	7	8	9	10	11	6		12	13	14	15	16	17	18	32
		12	13	14	15	16	17	18	7		19	20	21	22	23	24	25	33
		19	20	21	22	23	24	25	8		26	27	28	29	30	31		34
		26	27	28	29				9									35
MAR					1	2	3		9	SEP	2	3	4	5	6	7	8	35
		4	5	6	7	8	9	10	10		9	10	11	12	13	14	15	36
		11	12	13	14	15	16	17	11		16	17	18	19	20	21	22	37
		18	19	20	21	22	23	24	12		23	24	25	26	27	28	29	38
		25	26	27	28	29	30	31	13		30							39
											31							40
APR		1	2	3	4	5	6	7	14	OCT	7	8	9	10	11	12	13	40
		8	9	10	11	12	13	14	15		14	15	16	17	18	19	20	41
		15	16	17	18	19	20	21	16		21	22	23	24	25	26	27	42
		22	23	24	25	26	27	28	17		28	29	30	31				43
		29	30						18									44
MAY				1	2	3	4	5	18	NOV	4	5	6	7	8	9	10	44
		6	7	8	9	10	11	12	19		11	12	13	14	15	16	17	45
		13	14	15	16	17	18	19	20		18	19	20	21	22	23	24	46
		20	21	22	23	24	25	26	21		25	26	27	28	29	30		47
		27	28	29	30	31			22									48
JUN						1	2		22	DEC	2	3	4	5	6	7	8	48
		3	4	5	6	7	8	9	23		9	10	11	12	13	14	15	49
		10	11	12	13	14	15	16	24		16	17	18	19	20	21	22	50
		17	18	19	20	21	22	23	25		23	24	25	26	27	28	29	51
		24	25	26	27	28	29	30	26		30	31						52
																		1

Capacity Model variant
 Non-TCR standard day for TT2024
 Weekend variant for TT2024
 School holiday variant for weekdays for TT2024

15 December 00:01 Start of the timetable 2025

6.3.3. Variants for TCR / TCR window periods

The main aim of the creation of variants for TCR / TCR window periods is to transparently announce and communicate to stakeholders the estimated capacity to be consumed by TCRs (based on the available information on TCRs) and overview of capacity volumes that will IMs need to do the infrastructure maintenance. The Capacity Model variants for TCR/TCR window periods should show in a wider geographical area the applied traffic solution, which contains all volumes (incl. cancelled, replaced and re-routed volumes etc.) on the affected parts of the network during the TCR/TCR window period.

The IMs shall start the Annex VII compliant coordination and consultation on the execution of the Major and High impact TCRs (parameters of the construction/closure) before X-24 with the aim of providing a stable background for the definition of Capacity Model variants (information on the granularity and outputs at different milestones can be found in point 6.5.)

By X-24 the concerned IMs shall agree and transparently indicate the followings in connection with:

- Major impact TCRs:
 - Draft Capacity Model variant for TCR period is published at X-21 and Final Capacity Model variant for TCR period is published at X-18 (in case of necessity extended Capacity Model variant can be created) **or**,
 - Only Final Capacity Model variant for TCR period is published at X-18 (in case of necessity extended Capacity Model variant can be created in line with point 5.2.5.). In this case, the IMs continuously consult the Applicants during the definition of variant for TCR period.

- High impact TCRs:
 - Draft Capacity Model variant for TCR period is published at X-21 and Final Capacity Model variant for TCR period is published at X-18 (in case of necessity extended Capacity Model variant can be created) **or**,
 - Only Final Capacity Model variant for TCR period is published at X-18 (in case of necessity extended Capacity Model variant can be created in line with point 5.2.5.). In this case the IMs continuously consult the Applicants during the definition of variant for TCR period **or**,
 - Extended Capacity Model variant for TCR period is published at X-12 in draft and at X-11 in a final form.¹⁹

In case of disagreement between the IMs in connection with the possible creation of Capacity Model variants for TCR periods the IMs shall strive to find the commonly acceptable option²⁰.

Taking into account that the TCR planning is an iterative process it has to be ensured by the IMs that the changes in the main parameters of TCRs are continuously updated in the TCR tool, which shall "inform" via ECMT the concerned IM, that the Capacity Model variant has to be aligned to the updated information (e.g. if there are changes in the parameters of TCR then the variant can be extended at X-12/11).

The IMs are free to create Capacity Model variants also for lower impact TCRs, the decision-making should consider on one hand the business trends (own forecasts, information received via CNAs) and on other hand also the available resources (HR, IT).

The below calendar displays the case, when the IM defined the following variants for the TT period for a selected section of a railway line:

- Non-TCR standard day (green)
- Variant for weekends (blue)
- Variant for weekdays during school holidays (yellow)
- Variants for a Major and a High impact TCRs (red)

¹⁹ After the full implementation of TTR these high impact TCRs will be considered only in the Capacity Supply, as the Capacity Model extensions will be phased out.

²⁰ The details of a possible escalation process will be elaborated.

RNE		CAPACITY MODEL - CALENDAR VIEW - TT2024															
RailNetEurope		RAILWAY LINE Dresden Hbf --> Berlin Hbf, SECTION Dresden Hbf --> Elsterwerda															
2024	MON	TUE	WED	THU	FRI	SAT	SUN	WEEK	MON	TUE	WED	THU	FRI	SAT	SUN	WEEK	
JAN								52	JUL								27
	1	2	3	4	5	6	7	1		1	2	3	4	5	6	7	27
	8	9	10	11	12	13	14	2		8	9	10	11	12	13	14	28
	15	16	17	18	19	20	21	3		15	16	17	18	19	20	21	29
	22	23	24	25	26	27	28	4		22	23	24	25	26	27	28	30
	29	30	31					5		29	30	31					31
FEB									AUG								
				1	2	3	4	5				1	2	3	4		31
	5	6	7	8	9	10	11	6		5	6	7	8	9	10	11	32
	12	13	14	15	16	17	18	7		12	13	14	15	16	17	18	33
	19	20	21	22	23	24	25	8		19	20	21	22	23	24	25	34
	26	27	28	29				9		26	27	28	29	30	31		35
MAR									SEP								
				1	2	3		9								1	35
	4	5	6	7	8	9	10	10		2	3	4	5	6	7	8	36
	11	12	13	14	15	16	17	11		9	10	11	12	13	14	15	37
	18	19	20	21	22	23	24	12		16	17	18	19	20	21	22	38
	25	26	27	28	29	30	31	13		23	24	25	26	27	28	29	39
										30							40
APR									OCT								
	1	2	3	4	5	6	7	14			1	2	3	4	5	6	40
	8	9	10	11	12	13	14	15		7	8	9	10	11	12	13	41
	15	16	17	18	19	20	21	16		14	15	16	17	18	19	20	42
	22	23	24	25	26	27	28	17		21	22	23	24	25	26	27	43
	29	30						18		28	29	30	31				44
MAY									NOV								
				1	2	3	4	18					1	2	3		44
	6	7	8	9	10	11	12	19		4	5	6	7	8	9	10	45
	13	14	15	16	17	18	19	20		11	12	13	14	15	16	17	46
	20	21	22	23	24	25	26	21		18	19	20	21	22	23	24	47
	27	28	29	30	31			22		25	26	27	28	29	30		48
JUN									DEC								
						1	2	22								1	48
	3	4	5	6	7	8	9	23		2	3	4	5	6	7	8	49
	10	11	12	13	14	15	16	24		9	10	11	12	13	14	15	50
	17	18	19	20	21	22	23	25		16	17	18	19	20	21	22	51
	24	25	26	27	28	29	30	26		23	24	25	26	27	28	29	52
										30	31						1

Capacity Model variant

- Non-TCR standard day for TT2024
- Weekend variant for TT2024
- School holiday variant for weekdays for TT2024
- Variant for Major impact TCR for TT2024
- Variant for High impact TCR for TT2024

15 December 00:01 Start of the timetable 2025

The capacity consumed by the TCR will be visualised in the Capacity Model variant based on assumptions, which shall consider the categorisation of the TCR (national/international) and all other relevant information (e.g. in case of total closure 100% of the capacity is consumed etc.)²¹. This information (categorisation of TCRs & other relevant parameters) shall be uploaded into the TCR tool and shall be transferred to ECMT.

The below example displays the situation when the IM decided to initiate a total closure on a section in the mornings for 10 days. According to the information received from the TCR tool this a total closure, thus, 100% of the capacity shall be marked as negative capacity from 00:00 to 10:00 in ECMT. Furthermore, the IM indicated by X-24, that Capacity Model variant shall be prepared for the period of this TCR:

²¹ The applied categorisation and other pre-defined parameters (e.g. 100% capacity consumption in case of total closures) shall be incorporated into the Capacity Strategy.

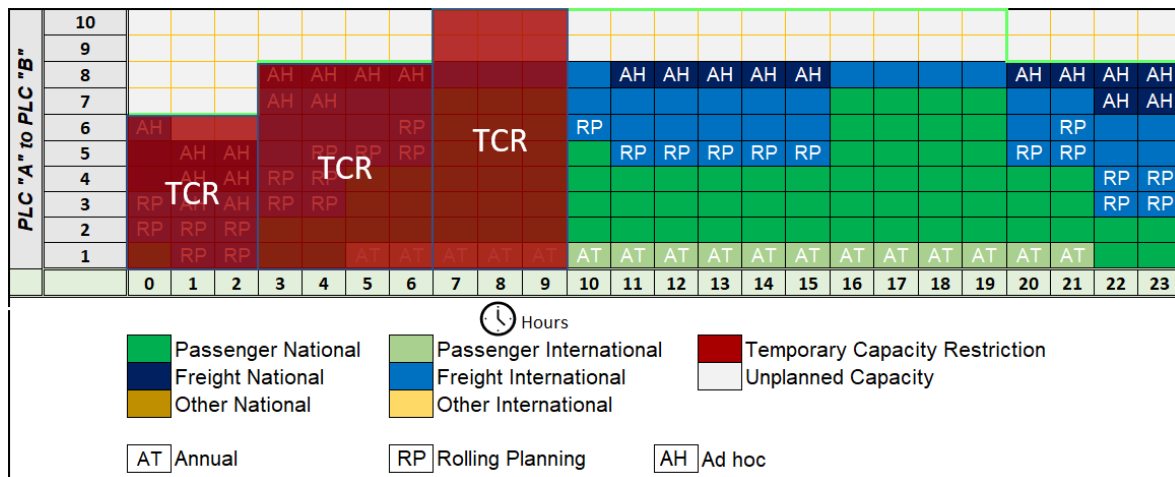

Capacity Model variants for TCR / TCR window periods are created for all affected part of the network (from PLC to PLC):

- Part of the network, where the TCR or TCR window occurs: Full/partial closure → volumes have to be cancelled/re-routed (section A → B on the below figure)
- Part of the network, which is affected by a TCR or TCR window²²:
 - Due to the TCR some volumes are cancelled or re-routed (section B → C on the below figure: freight and long-distance passenger volumes are re-routed)
 - Those parts of network where additional volumes are incorporated into the Capacity Model (section A → F → G → C on the below figure: freight and long-distance passenger volumes are re-routed)

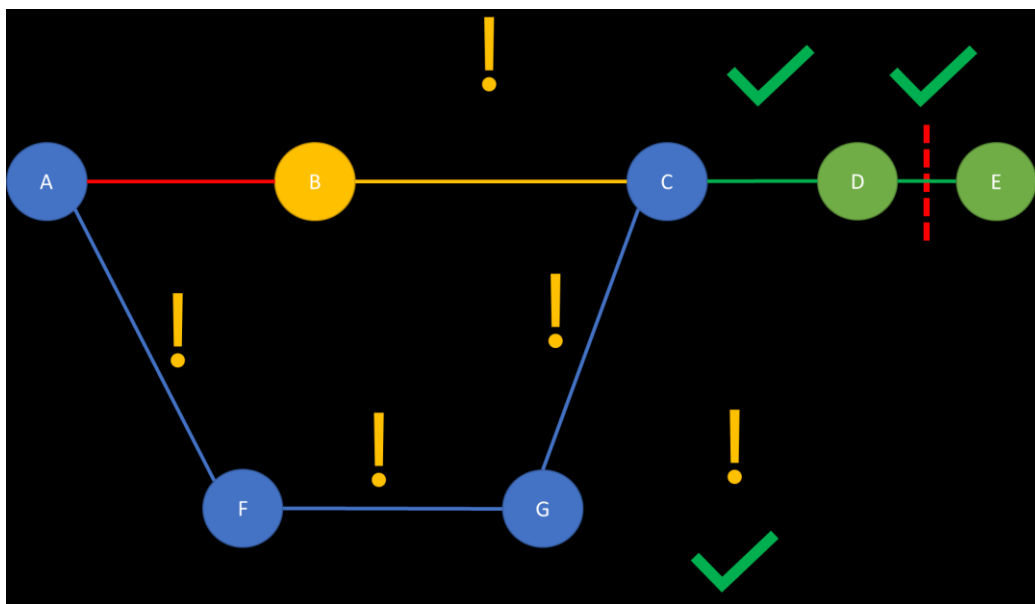

In case the TCR or the TCR window has effects on the volumes at a border section, then the Capacity Model variant(s) shall be coordinated with the neighbouring IM. The coordination on the volumes should be initiated by the IM, on whose network the closure can be found.

²² The diversionary lines to be used during TCR periods are defined as part of the TCR coordination, therefore, the TCR tool contains the relevant information on them.

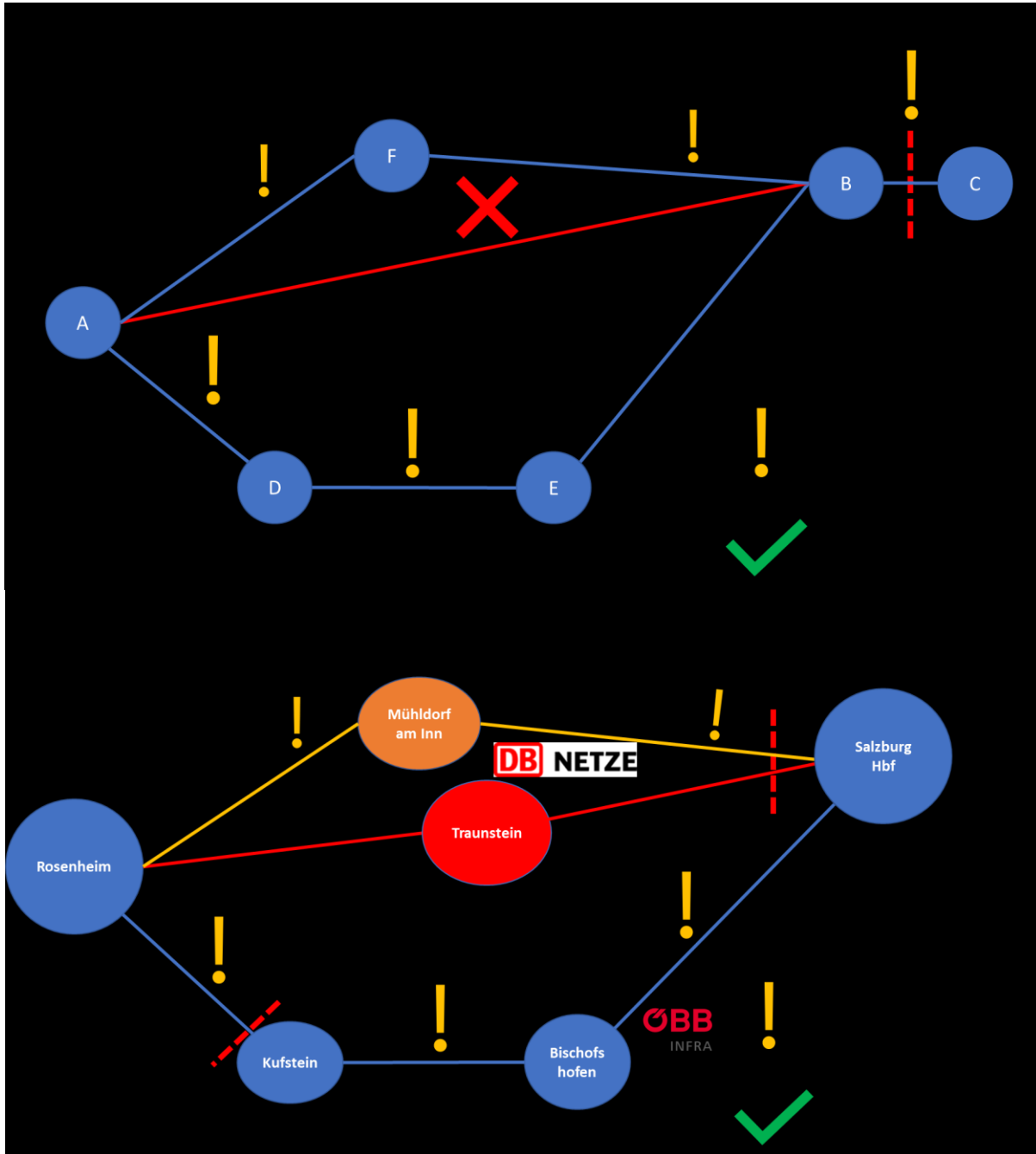

Besides the standard information on traffic volumes the final versions of Capacity Model variants for TCR periods contain the following information based on the data transferred from the TCR tool:

- a) Approximate duration and period,
- b) Time of day, and, as soon as it can be set, the hour of the beginning and the end of the capacity restriction,
- c) Section of line affected by the restriction (from PLC to PLC),
- d) Capacity of diversionary lines along with an overview of which type of service should be rerouted (if applicable),
- e) Opening times of the diversionary line(s) and technical constrains for operation (for instance traction, max weight, max lengths, gradients, clearance profile)

Further examples on the visualisation of Capacity Models can be found in Annex C.

6.4. Sources of input

IMs should use different input to construct/extend a Capacity Model. These sources are:

- **Capacity Strategy.**
- **Competent authorities:** information provided by them already in the Capacity Strategy phase such as expected public service obligation (PSO) traffic flows (for the traffic part) and available funding for new capacity related projects (for the variants for TCR periods).
- **Multi-annual Rolling Planning requests:** Rolling Planning requests placed already by applicants in the previous or running timetable period that is supposed to have running days also in the timetable period that is subject to capacity modelling²³.
- **Capacity Needs Announcements:** a process for entities (also potential ones) with interests in capacity usage by which they can announce their capacity needs and participate in the process of Capacity Model and Capacity Supply design.
- **Historical data:** data about train services operated in the current or previous years.
- **IM own analyses:** IMs’ estimations and own hypothesis of future market developments.
- **Framework agreements.**

Each of the inputs should be evaluated by IMs also from the point of reliability and stability, in order to construct Capacity Models that do not under/overestimate certain volumes, deviations from the market needs should be duly justified and documented.

6.5. Outputs

The IMs should publish the Capacity Models covering all types of expected traffic: passenger/freight at X-21 in a draft, at X-18 in final form. If there is a need for adjusting the published Capacity Models due to changed business needs or finished coordination of High impact TCRs the Capacity Models can be extended. During the creation of extended Capacity Models, the changes have to be consulted with the concerned Applicants (drafts of extended Capacity Models are published at X-12, final versions of extended Capacity Models are published at X-11).

During the definition of Capacity Models, it has to be checked which sections of infrastructure have been declared congested (as defined by Article 47 of Directive 2012/34/EU). Based on the already prepared capacity enhancement plan (as defined by Article 51 of Directive 2012/34/EU) the IM can identify those sections, where the congestion cannot be released for the TT period covered by the Capacity Model (e.g. during the preparation of Capacity Model for TT2026, in summer 2024 it shall be checked which parts of the network have been considered as congested and foreseen to be still congested in TT2026 based on the capacity enhancement plan). In these special cases volumes should be dedicated also to ad hoc and rolling planning purposes in order to fully utilise the added values of strengthened long-term planning activities of IMs.

The below table summarises the outputs, which shall be published by the IMs in line with the agreed timeline:

Milestone	Output
X-21	Publication of draft Capacity Models Standard non-TCR working day (mandatory) Variants for particular periods such as different days of the week, school days, weekends, summer/winter holidays etc (optional) Variants for TCR periods (recommended for Major & High impact TCRs) Variants for TCR window periods to the extent they are known (highly recommended)
X-18	Publication of final Capacity Models Standard non-TCR working day (mandatory)

²³ Note: this will not be relevant in TT2025

	<p>Variants for particular periods such as different days of the week, school days, weekends, summer/winter holidays etc (optional)</p> <p>Variants for TCR periods (mandatory for Major & recommended for High impact TCRs)</p> <p>Variants for TCR window periods to the extent they are known (highly recommended)</p>
X-12	<p>Publication of the draft version of extended Capacity Models²⁴</p> <p>Standard non-TCR working day (mandatory)</p> <p>Variants for particular periods such as different days of the week, school days, weekends, summer/winter holidays etc (optional)</p> <p>Variants for TCR periods (mandatory in case of changes for Major & mandatory High impact TCRs)</p> <p>Variants for TCR window periods to the extent they are known (highly recommended)</p>
X-11	<p>Publication of the extended Capacity Models²⁵</p> <p>Standard non-TCR working day (mandatory)</p> <p>Variants for particular periods such as different days of the week, school days, weekends, summer/winter holidays etc (optional)</p> <p>Variants for TCR periods (mandatory in case of changes for Major & mandatory High impact TCRs)</p> <p>Variants for TCR window periods to the extent they are known (highly recommended)</p>

²⁴ In case the final Capacity Model (published at X-18) reflects to the business needs properly, then the creation of extended versions is not mandatory.

²⁵ In case the final Capacity Model (published at X-18) reflects to the business needs properly, then the creation of extended versions is not mandatory.

Annex A: Process diagram for Capacity Model

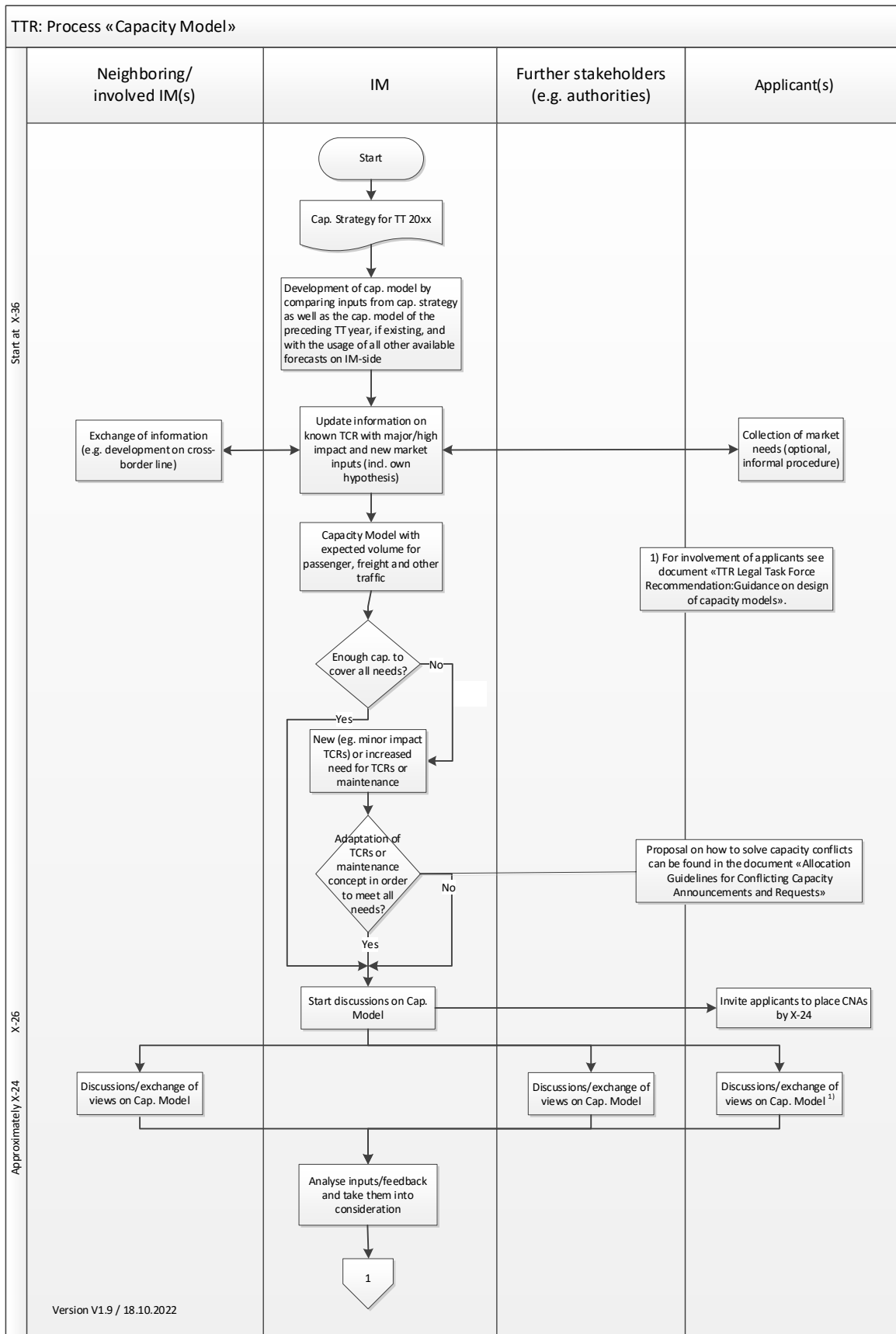

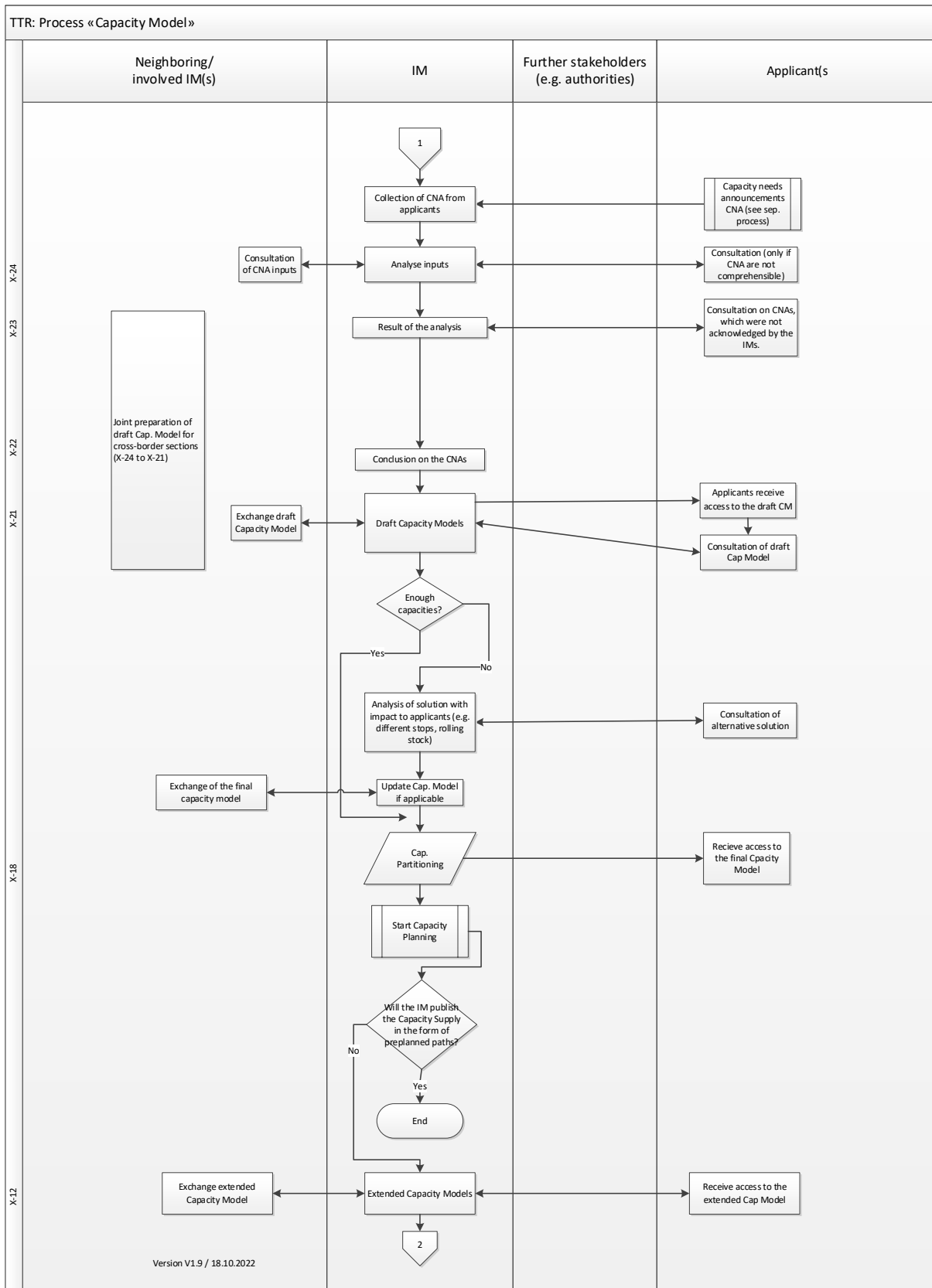

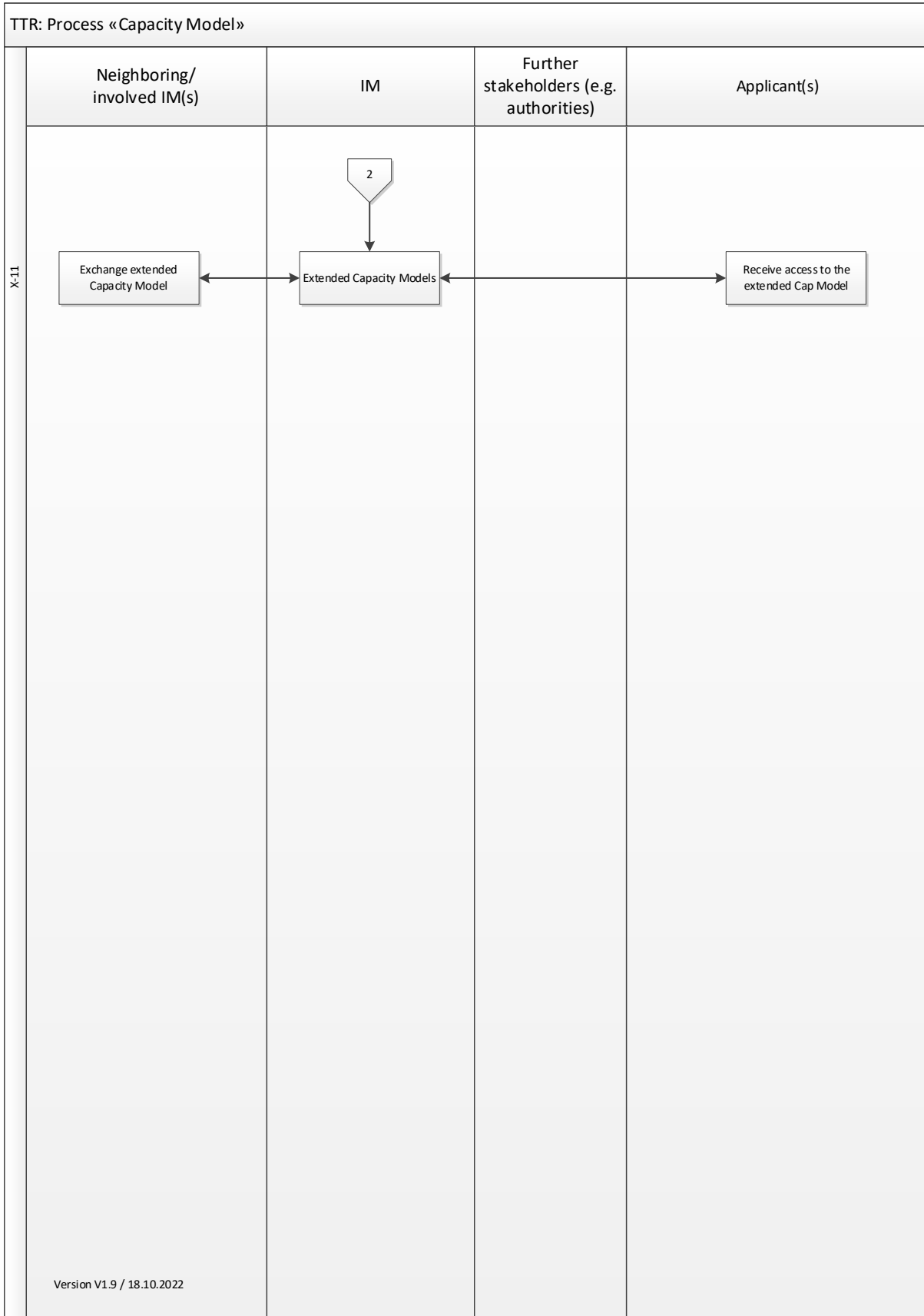

Annex B: Roadmap to Capacity Model

Stakeholder	X-36 ²⁶	X-36 > X-24	X-24 > X-21	X-18	X-18 > X-12 ²⁷	X-12 > X-11
“Leading international entity for capacity planning and management”	Get access to the Capacity Models of the IM in elaboration.* CMO-LE-040	Coordinates the exchange of information and analysis on capacity needs announcements. Ensures international harmonisation of Capacity Models. Administratively organises meetings and communicates information to stakeholders. Monitors that the draft Capacity Model is according to the agreed capacity strategy.* CMO-LE-050	Coordinates the exchange of information and analysis on capacity needs announcements. Ensures international harmonisation of Capacity Models. Administratively organises meetings and communicates information to stakeholders. Monitors that the draft Capacity Model is according to the agreed Capacity Strategy.* CMO-LE-060	Ensures timely and correct publication of all Capacity Models.* CMO-LE-070	Ensures timely and correct publication of all Capacity Models.* CMO-LE-080	Ensures timely and correct publication of all Capacity Models.* CMO-LE-090
IM	Copies the previous Capacity Models and starts the model update. CMO-IM-040	Analyses upcoming capacity needs announcements, updates the capacity models also with the expected capacity consumed by all TCRs. Meets regularly with other concerned IMs to exchange information and agree on the intended volume (including quality) to be offered to international traffic. CMO-IM-050	Draft internationally harmonised capacity models are finished. Consults the applicants of which capacity needs cannot be fully considered in the models. Fine-tunes the models. CMO-IM-060	Performs the final capacity partitioning and publishes all Capacity Models. CMO-IM-070	Draft version of extended Capacity Models by X-12. Consults the applicants of which capacity needs cannot be fully considered in the models. Fine-tunes the models. CMO-IM-080	Final version of extended Capacity Models at X-11. Consults the applicants of which capacity needs cannot be fully considered in the models. Fine-tunes the models. CMO-IM-090
Other concerned IMs	Get access to the Capacity Models of the IM in elaboration. CMO-OI-040	Provide information on capacity needs, which might affect the work on the model of the IM. Agree with the IM on the intended volume (including quality) to be offered to international traffic. CMO-OI-050				
RU applicants		Provide capacity needs announcements. CMO-RU-050	Answers to the IM if it is called for a consultation. Gets access to the draft capacity models. CMO-RU-060		Answers to the IM if it is called for a consultation. Gets access to the extended capacity models. CMO-RU-080	Answers to the IM if it is called for a consultation. Gets access to the extended Capacity Models. CMO-RU-090
Non-RU applicants		Provide capacity needs announcements. CMO-NR-050	Answers to the IM if it is called for a consultation. Gets access to the draft capacity models. CMO-NR-060		Answers to the IM if it is called for a consultation. Gets access to the extended capacity models. CMO-NR-080	Answers to the IM if it is called for a consultation. Gets access to the extended Capacity Models. CMO-NR-090
MoT (Ministry of Transport)		Is actively consulted, especially for capacity models in bottleneck segments. CMO-MT-050		Gets access to the Capacity Models. CMO-MT-070	Gets access to the Capacity Models. CMO-MT-080	Gets access to the Capacity Models. CMO-MT-090
RB (Regulatory Body)				Gets access to the Capacity Models. CMO-RB-070	Gets access to the Capacity Models. CMO-RB-080	Gets access to the Capacity Models. CMO-RB-090
Regions, local governments, transport associations, industries				Gets access to the extended Capacity Models. CMO-RE-070	Gets access to the extended Capacity Models. CMO-RE-080	Gets access to the extended Capacity Models. CMO-RE-090
Operators of service facilities	Gets access to the Capacity Models. CMO-TS-040		Answers to the IM if it is called for a consultation. CMO-TS-060		Answers to the IM if it is called for a consultation. CMO-TS-080	Answers to the IM if it is called for a consultation. CMO-TS-090
IT	Capacity hub allows carry forward of the previous model and desired access rights. Geography from CRD is impartible to the hub. CMO-IT-040	Capacity hub supports all necessary capacity elements, allows coordination via commenting functions and tracks versioning. Capacity hub allows submitting capacity needs announcements via upload to the capacity hub (via the standardised template). CMO-IT-050	Transfers and visualises the TCRs from TCR Tool. CMO-IT-060	Capacity hub supports publication of Capacity Models and possibility to display models for different levels of granularity. CMO-IT-070	Transfers and visualises the TCRs from TCR tool. CMO-IT-080	Transfers and visualises the TCRs from TCR Tool. CMO-IT-090
Legal framework				Law empowers IMs to make a binding capacity partitioning. CMO-LF-070 / CMO-LF-080 / CMO-LF-090		

²⁶ Note that while the fully implemented TTR assumes this milestone at X-36, for TT2025 it is set as X-30 (June 2022).

²⁷ After the full implementation of TTR the Capacity Model timeline will end at X-18, therefore, the Capacity Model extensions will be phased out and the preparation of Capacity Supply will begin at the same time.

* Due to ongoing activities in TTR projects in this regards, further description and involvement of this entity are currently out of the scope of this document.

Annex C: Visualisation of Capacity Model

The Capacity Models can be visualised in three different formats:

1. Network overview

The ECMT will be able to generate an overview on the capacity situation on network level on daily or hourly basis using on one hand the uploaded information on the volumes and TCRs, and on the other hand the intended capacity usage line. The tool shall differentiate between the below categories within the overview:

- Possible capacity shortage: Volume(s) can be found in the analysed period already above the intended capacity usage line.
- Sufficient capacity: The number of planned volumes is under the intended capacity usage line and consumes in case of
 - hourly overview more than 80%
 - daily overview more than 50%of the available capacities under the intended capacity usage line.
- Capacity surplus: The number of planned volumes is under the intended capacity usage line and there is room for unplanned capacities to accommodate additional needs (volumes consume in case of hourly overview less than 80% / daily overview less than 50% of the available capacities under the intended capacity usage line).

The Network overview is important for the identification of possible capacity bottlenecks on a broader scale. The IMs and stakeholders will have a complete picture on the situation allowing them to initiate the necessary measures to release the capacity situation, if needed.

A possible visualisation can be found below:

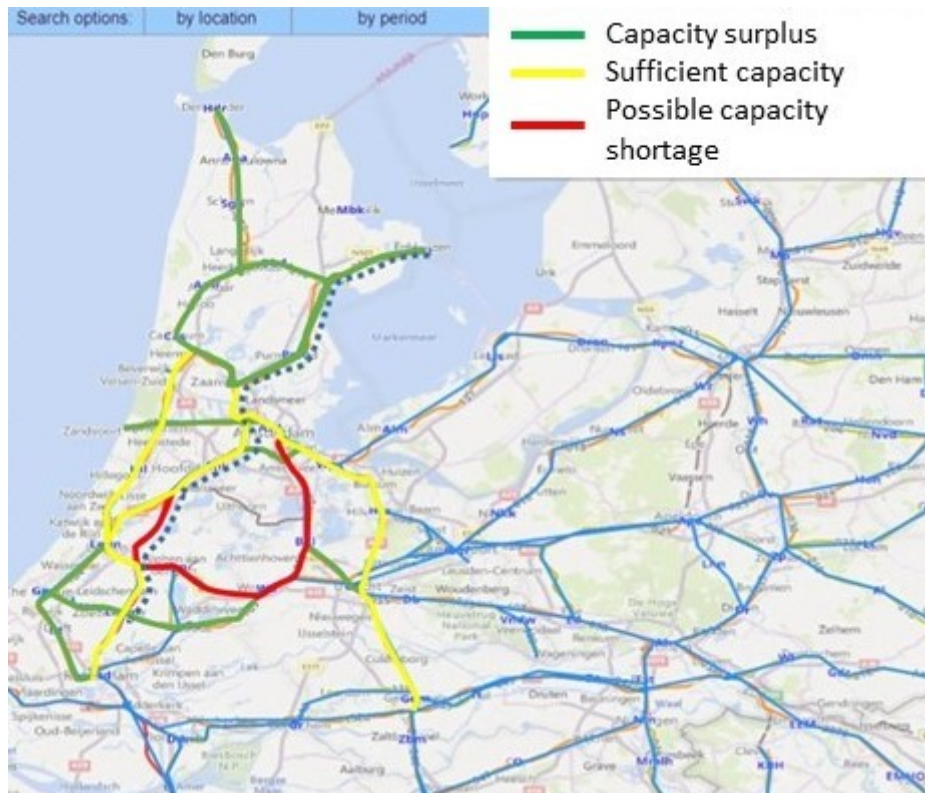

2. Line overview

A railway line level overview should be generated by the ECMT based on the provided information by the IMs. The identification of the volumes is done with the usage of the dedicated IDs. These visualised summaries of the planned volumes can be used for the verification of the IMs` inputs, and also for cross-border harmonisation and TCR-consultation purposes.

As first step for the generation of a line level overview the concerned PLCs shall be set by the user (min: origin & destination and at least one PLC / railway line). The generated Capacity Model analyses the situation at the defined measuring points (PLCs), time information of volumes refers to hourly departures from PLCs and the duration of the occupation of the volumes will not be considered in the Capacity Model.

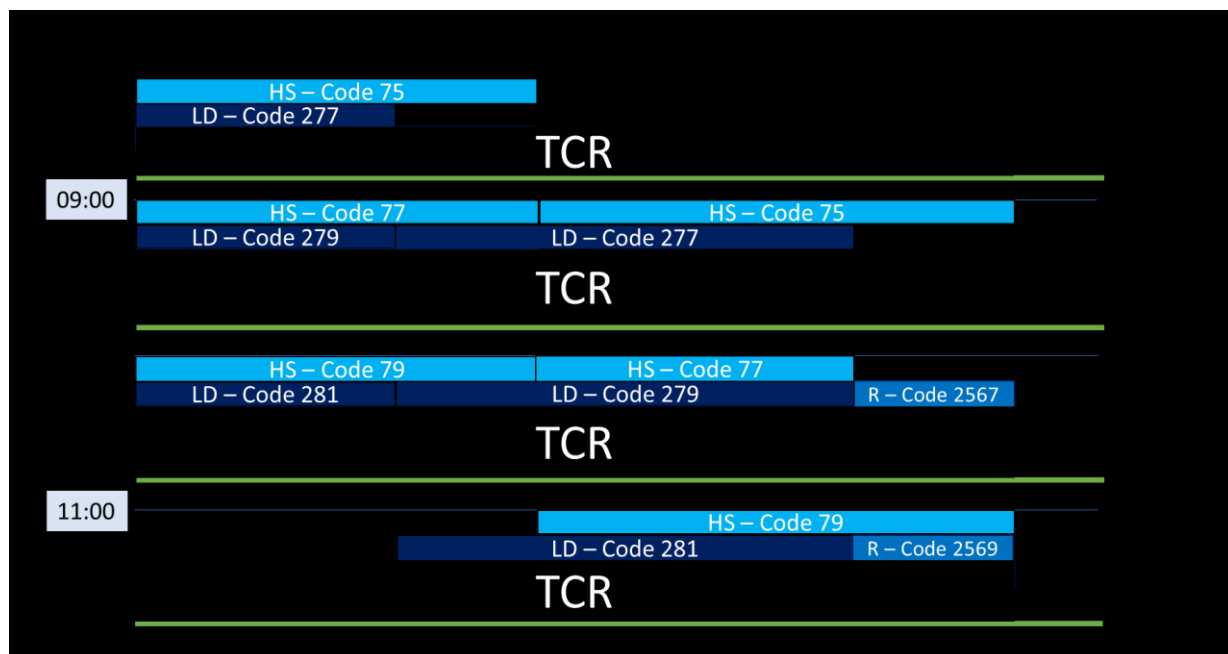
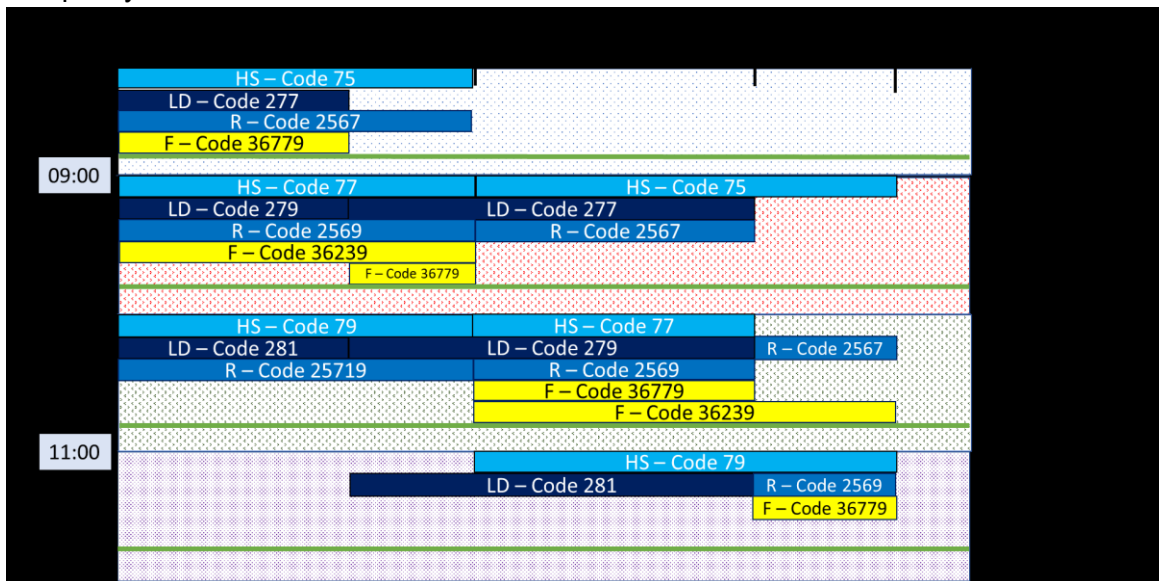

3. Section overview

Each of the traffic volumes can be displayed as a single train run (square) or package of future slots (rectangle) per direction. The stakeholders should acknowledge that the number of slots is based on

the standard parameters of the particular category. A deviation can lead to usage of more slots for a single train run. The examples below show one of the potential visualisations of the future traffic part of a Capacity Model.

Example A: an IM displays ATT (freight & passenger) and RP volumes. The railway line A → C can be divided into two parts (A → B, B → C). The intended capacity usage line is based on historical data stemming from TIS/national traffic management system (please see Annex G).

The first Capacity Model (A → B) contains those trains, which pass (origin / run through) the first measuring point at point A, and run towards point B independently from the destination (B or C).

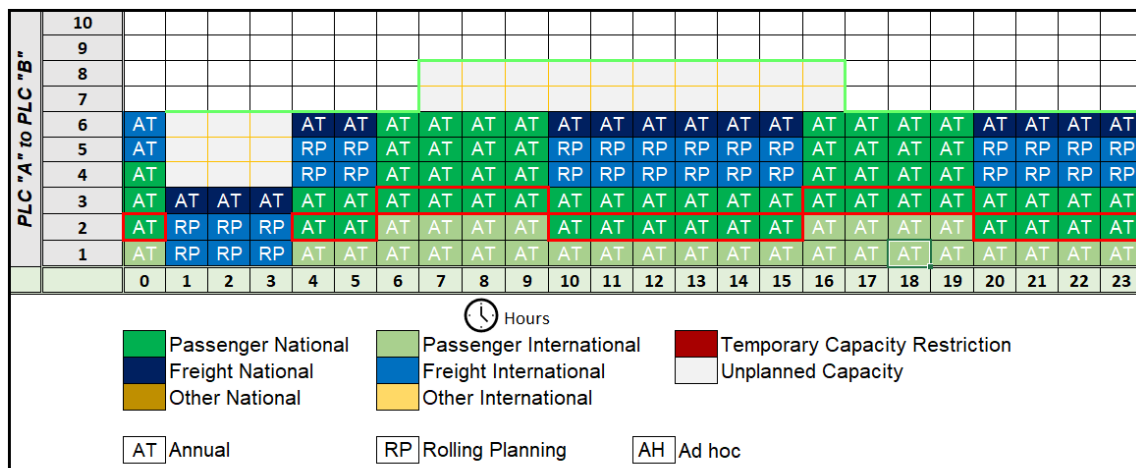

- high-speed
- long-distance
- express-regional
- regional
- wagonload
- block
- combined

Capacity Model (A → B)

The second Capacity Model (B → C) contains those trains, which pass (origin / run through) the first measuring point at point B and run towards point C independently from the origin (A or B).

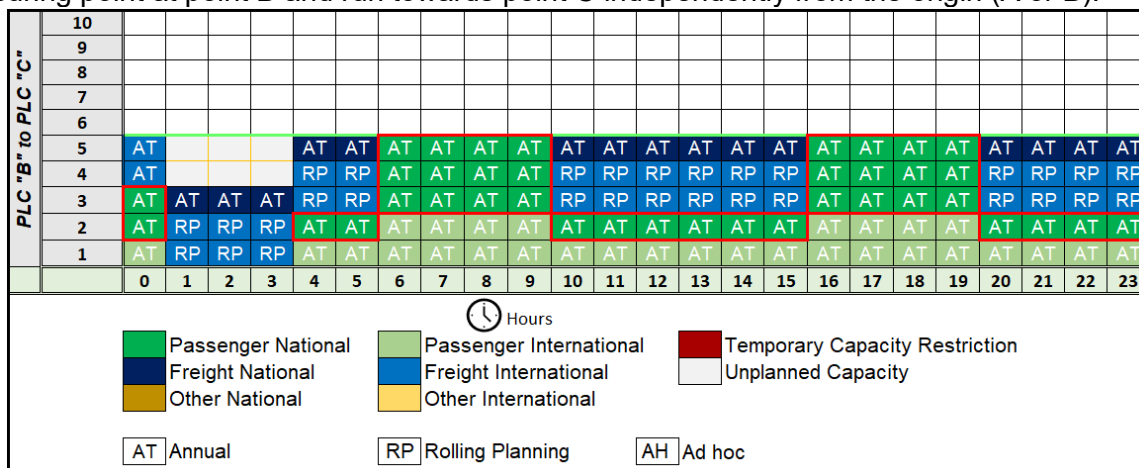

- high-speed
- long-distance
- express-regional
- regional
- wagonload
- block
- combined

Capacity Model (B → C)

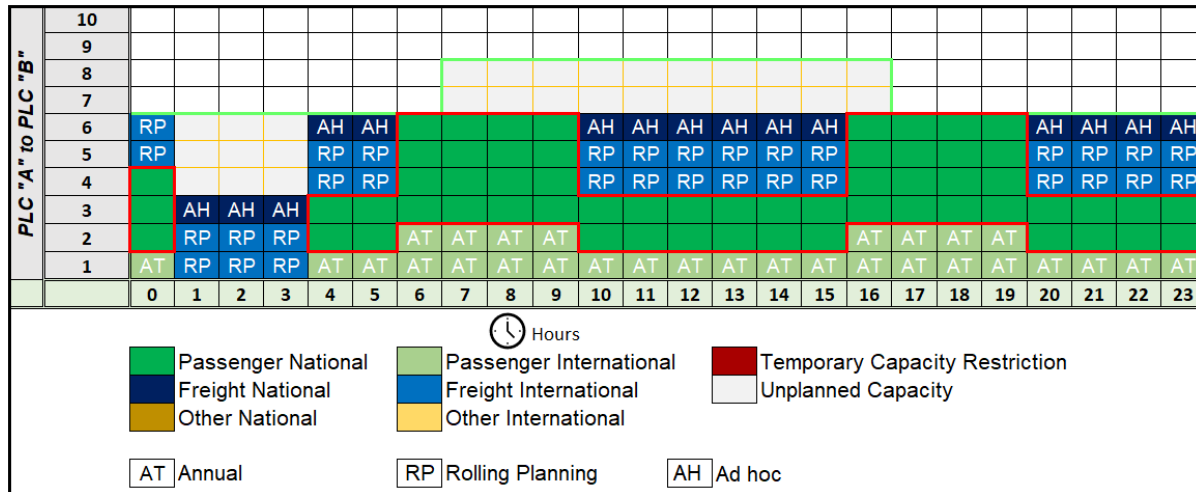

- high-speed
- long-distance
- express-regional
- regional
- wagonload
- block
- combined

Example of the traffic part of the Capacity Model C

Example D: is a regional single-track line with low importance; the trains are planned in detail (volume per particular hour), rest of the capacity is left as unplanned. The intended capacity usage line was calculated for each direction based on the IM's own estimations, the traffic is suspended on each day from 23:00 till 05:00.

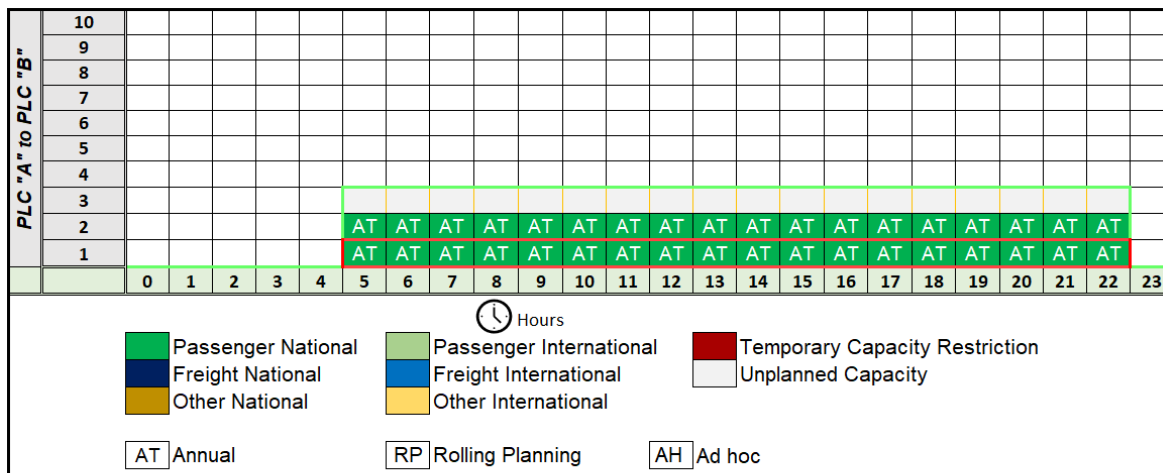

- high-speed
- long-distance
- express-regional
- regional
- wagonload
- block
- combined

Figure 1: Example of the traffic part of the Capacity Model D

Example E: is a single-track line. The intended capacity usage line was calculated based on the IM's own estimations. According to the results the line can accommodate approximately 6 volumes per hour in total. The ECMT will indicate in case of capacity overbookings in both directions to raise the attention of the IMs to need for adjustments.

PLC "A" to PLC "B"	5																		
	4																		
	3	AT	AT	AT	AT	AT	AT	AT	AT	AT	AT	AT	AT	AT	AT	AT	AT	AT	AT
	2	AT	AT	AT	AT	AT	AT	AT	AT	AT	AT	AT	AT	AT	AT	AT	AT	AT	AT
	1	AT	AT	AT	AT	AT	AT	AT	AT	AT	AT	AT	AT	AT	AT	AT	AT	AT	AT
		5	6	7	8	9	10	11	12	13	14	15	16	17	18	19			
🕒 Hours																			

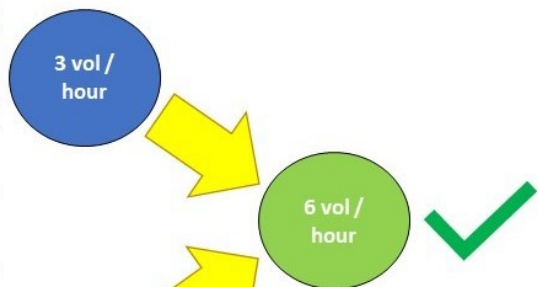

PLC "B" to PLC "A"	5																		
	4																		
	3	AT	AT	AT	AT	AT	AT	AT	AT	AT	AT	AT	AT	AT	AT	AT	AT	AT	AT
	2	AT	AT	AT	AT	AT	AT	AT	AT	AT	AT	AT	AT	AT	AT	AT	AT	AT	AT
	1	AT	AT	AT	AT	AT	AT	AT	AT	AT	AT	AT	AT	AT	AT	AT	AT	AT	AT
		5	6	7	8	9	10	11	12	13	14	15	16	17	18	19			
🕒 Hours																			



PLC "A" to PLC "B"	5																		
	4	AT	AT	AT	AT	AT	AT	AT	AT	AT	AT	AT	AT	AT	AT	AT	AT	AT	AT
	3	RP	RP	RP	RP	RP	RP	RP	RP	RP	RP	RP	RP	RP	RP	RP	RP	RP	RP
	2	AT	AT	AT	AT	AT	AT	AT	AT	AT	AT	AT	AT	AT	AT	AT	AT	AT	AT
	1	AT	AT	AT	AT	AT	AT	AT	AT	AT	AT	AT	AT	AT	AT	AT	AT	AT	AT
		5	6	7	8	9	10	11	12	13	14	15	16	17	18	19			
🕒 Hours																			

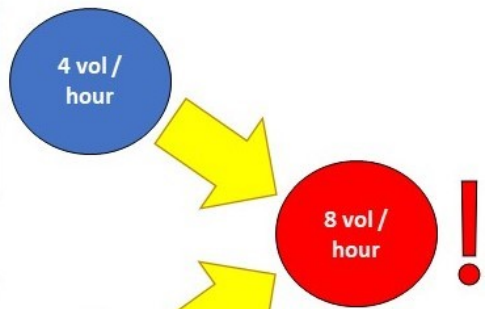

PLC "B" to PLC "A"	5																		
	4	AT	AT	AT	AT	AT	AT	AT	AT	AT	AT	AT	AT	AT	AT	AT	AT	AT	AT
	3	RP	RP	RP	RP	RP	RP	RP	RP	RP	RP	RP	RP	RP	RP	RP	RP	RP	RP
	2	AT	AT	AT	AT	AT	AT	AT	AT	AT	AT	AT	AT	AT	AT	AT	AT	AT	AT
	1	AT	AT	AT	AT	AT	AT	AT	AT	AT	AT	AT	AT	AT	AT	AT	AT	AT	AT
		5	6	7	8	9	10	11	12	13	14	15	16	17	18	19			
🕒 Hours																			



Example of the traffic part of the Capacity Model E

Example F: is a congested line where the IM displays ATT, RP, ad hoc and unplanned volumes and planned with alternative solutions for hours of 06:00 and 16:00 on one hand to ensure more flexibility to the applicants and on the other hand it is possible that due to organisational reasons the intended capacity usage line has to be lowered for these hours. The intended capacity usage line was calculated based on historical information stemming from the IT-tools (TIS & national).

Example of the traffic part of the Capacity Model G

Visualisation of TCRs in the model:

In the below example a section can be seen with 184 planned and 2 unplanned volumes:

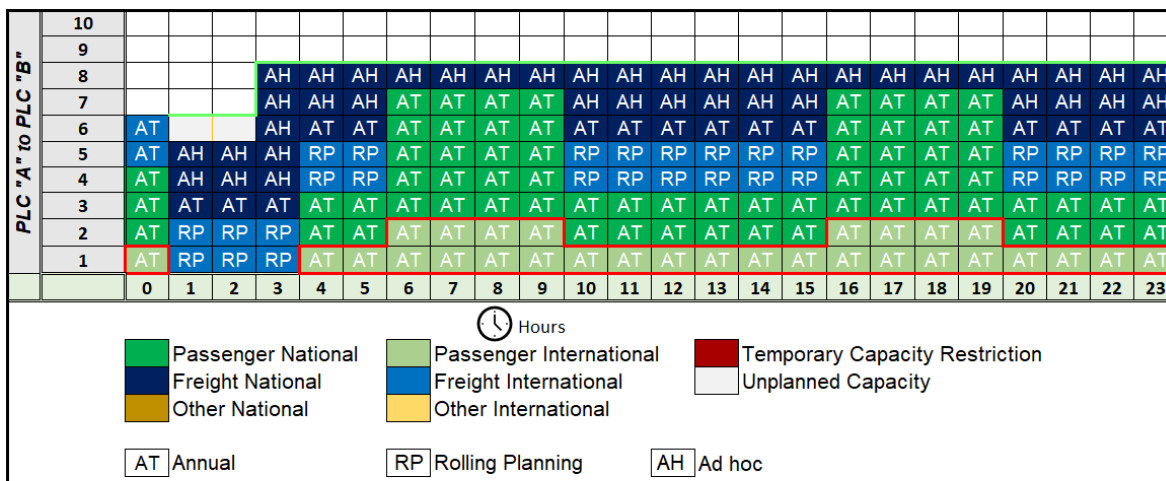

- high-speed
- long-distance
- express-regional
- regional
- wagonload
- block
- combined

The IM decided to initiate a partial closure on the section for 60 days. Out of the 186 volumes 114 are affected with this TCR, which means that this is a Major TCR:

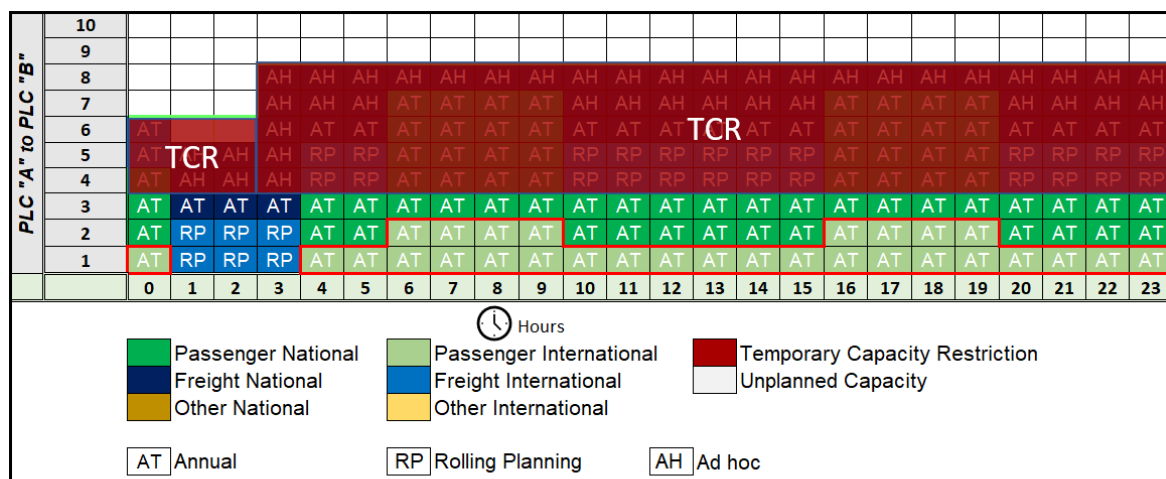

- high-speed
- long-distance
- express-regional
- regional
- wagonload
- block
- combined

Annex D: Process for Capacity Needs Announcements

The RUs and Non-RU Applicants are asked to participate in the design of the future capacity, balanced between freight services, passenger services, and capacity restrictions. The RUs and Non-RU Applicants do not have to be in the position of valid railway licence, nor to be based in the country of network for which they wish to submit CNAs. IMs are obliged to keep all submitted CNAs and any connected communication as strictly confidential.

Timeline	Milestone/Action
X-36 to X-27	<p>RUs communicate with competent authorities and Non-RU applicants and attempt to agree on which entity will submit the initial CNAs on behalf of the RUs involved into a certain traffic. This communication flow is to minimise double announcements.</p> <p>Entities conduct market-research, analyse historical data.</p> <p>Entities examine their potential partners for networks of the train run.</p>
X-26	<p>IMs invite the Applicants to submit CNAs. If IMs conduct the preliminary consultation of certain Major and High impact TCRs with Applicants until X-26 and provide them sufficient information and data to study rerouting scenarios at this stage, then IMs can ask Applicants to submit CNAs accordingly. In these cases, the IMs shall not make significant changes regarding the published/notified TCRs without consulting them in advance with the Applicants. (Coordination meeting of High and Major impact TCRs takes place at X-26.5).</p>
X-24	<p>Deadline to submit the Capacity Needs Announcements in the standardised format (Annex E).</p>
X-23	<p>The Applicants are notified about the result of the analysis of the IMs (Acknowledged/To be updated/Not (fully) considered).</p>
X-23 – X-22	<p>The not acknowledged CNAs shall be consulted between the concerned IMs and Applicants.</p>
X-22.5	<p>If the IMs ask for additional information on the CNA, then the Applicants shall send the requested set of information to the IMs.</p>
X-22	<p>The IMs conclude which CNAs will be taken into account during the creation of draft Capacity Models (Acknowledged/Not considered).</p>
X-21 to X-18	<p>The Applicants are given access to the published draft Capacity Model and shall be available for IMs. In this phase each entity, whose needs cannot be reflected in the model is called for consultation.</p>
X-18	<p>The final Capacity Model is published.</p>
X-18 to X-11	<p>Extended Capacity Models and Capacity Supply phase: the submitter of CNAs (or delegated Applicant) is available for IMs for further consultation on the timetabling details of the extended Capacity Model / Capacity Supply, including days when the capacity products are affected by TCRs.</p>

Neither the partitioned volumes, nor published Capacity Supply are considered as pre-allocation. Although a particular Applicant participated in the process of future capacity design, the published capacity products can be requested by any other Applicant. The provisions for situation where there are conflicting CNAs are written in Annex I.

The process chart of Capacity Needs Announcements can be found below:

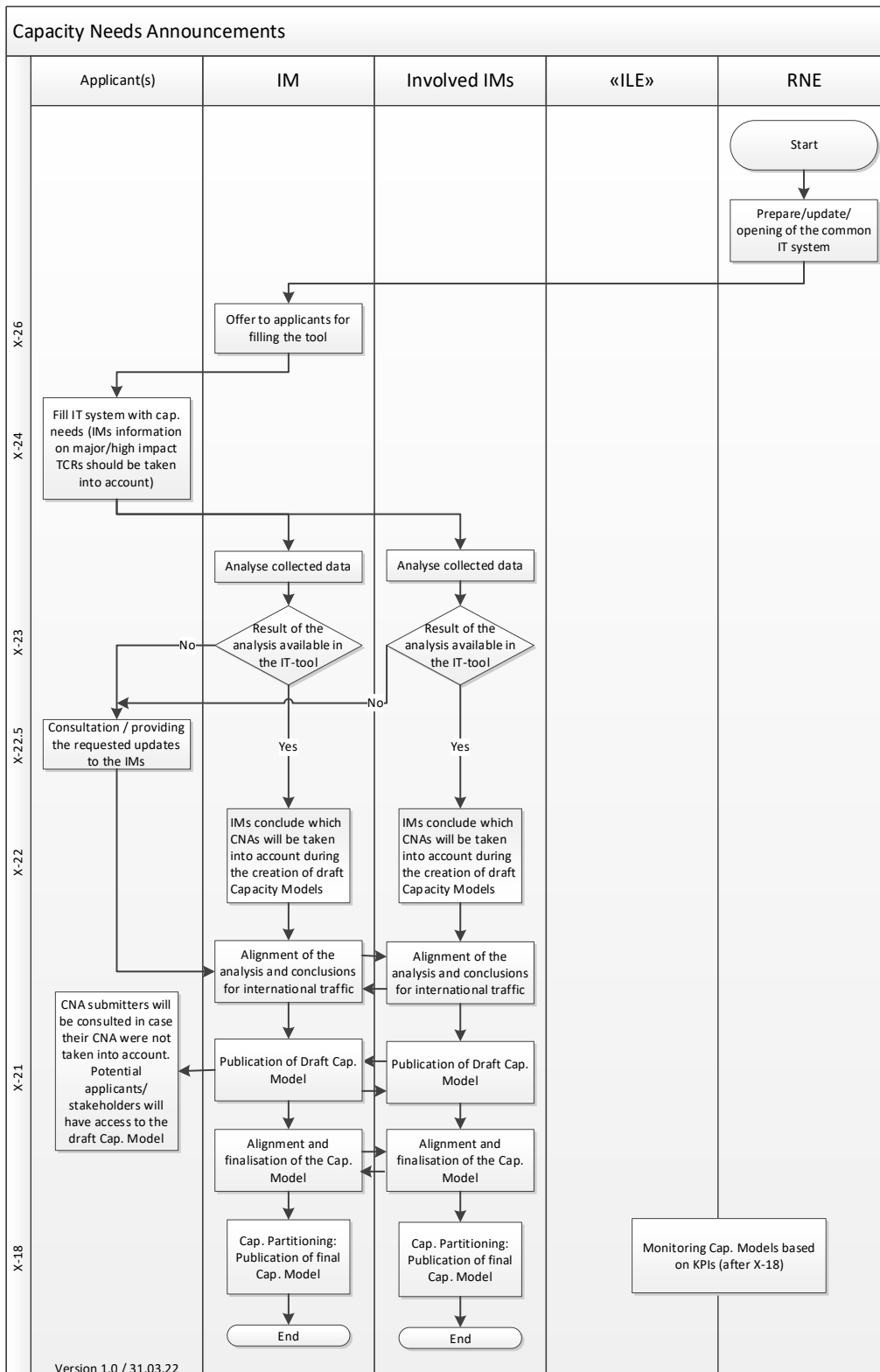

Annex E: Standardised template for Capacity Needs Announcements

Capacity needs announcements can be expressed in different ways:

- Indication 'Status quo' if no changes to the current offer are intended,
- Indication 'Status quo' with adaptations,
- New traffic (as much detailed and reliable input as possible).

It can be assumed that Applicants in the passenger market will make use of the possibility to deliver very detailed information. However, most Applicants in the freight market will find it difficult to indicate detailed data, but they are still encouraged to present their needs at least in terms of volumes (e.g., number of paths per day and line sections).

The below table²⁸ contains the basic set of information, which should (in case of mandatory fields) or can (in case of optional fields) be uploaded into the ECMT for the preparation of the Capacity Models and submission of Capacity Needs Announcements.

Field	Description	Field type	CNA	CM
ID	ID that combines all operational points/locations on different rows into a single object. By this you can enter several CNAs into the same excel sheet. Use one numerical ID of your selection for all rows of the same object.	mandatory	Yes	Yes
ObjectType	Alphanumerical field (2 characters). The relevant types: CN = CNA and for IMs it is for instance CP = Catalogue Path, PA = Path.	optional	Yes	Yes
Company	Alphanumerical field (4 characters) for the company code of the entity which created the object, the codes can be search//teleref.era.europa.eu/	optional	Yes	Yes
Core	Alphanumerical field (12 characters) for the core element of the planned transport identifier.	optional	Yes	Yes
Variant	Alphanumerical field (2 characters). For CNA/trains only 00 shall be used.	optional	Yes	Yes
TimeTableYear	The timetable period where the business will be carried out. Example: for timetable period from December 2024 to December 2025: Enter 2025.	optional	Yes	Yes
OTN	The "train number" or any national identifier that either the Applicant or the IM would like to assign to the CNA or CM object. It is only a desired number, no number allocation is part of the CNA process.	optional	Yes	Yes
Title	An optional field to provide a user-friendly naming of the object, so you can recognise it easier. It does not need to be unique.	mandatory	Yes	Yes

²⁸ The initial version of the standardised template might be modified based on the findings of CNA pilots.

CMVariant	An optional IM field. It shall be used only for the CM objects to connect them to a variant. One object can belong To more variants.	optional	No	Yes
LeadRU	It shall be used only for the CNA to state who is the leading applicant for the CNA. Enter the company code of the applicant, ied here: https://teleref.era.europa.eu/	optional	Yes	No
CoordinatingIM	Alphanumerical field (2 characters) IM field. It shall be used only for the CM, in case there is a coordinating IM.	-	No	Yes
TrainType	Enter the train type (Passenger, Freight). Please note that TAF code list has more values (see the sheet Code list).	mandatory	Yes	Yes
TrafficType	Related to the train type. Only valid traffic types can be selected: Passenger (high speed/long distance/express regional/regional), Freight (wagonload/blocktrain/combined transport).	optional	Yes	Yes
CapacityProductType	This field is related to the capacity partitioning. For CNA, you indicate what capacity product would be suitable for the CnA (see the sheet Code list).	optional	Yes	Yes
Category	Write if the traffic is either national or international.	mandatory	Yes	Yes
StatusQuo	This field is specific for CNAs and first years of TTR in case the applicant wishes to notify IMs also about the status quo. If the CNA is for a new or modified traffic skip it. For StatusQuo cases, write down the year from which the status quo is to be considered (e.g.2022). The applicant is given the chance to provide an OTN (see field OTN) of already allocated paths and in this way notify the IM that wishes to keep the status quo also for the timetable period for which the CNA is submitted.	optional	Yes	No
TrafficContracted	For freight: write "1" in case the traffic is already contracted or supply-driven. Write "0" if you are not fully sure that your company will be Selected to execute the carriage.	optional	Yes	No
TypeOfContract	In case you wrote "0" in the field TrafficContracted, write down description for IMs for which customer and or what kind of transport will you apply for. This is to allow IMs identify Double CNAs for the same transport.	optional	Yes	No

MaxJourneyTime	It shall be used only for the CNA to indicate the limit of the journey time from origin to the destination (hh:mm), wished by the applicant.	optional	Yes	No
CountryCodeISO	2-character ISO code of the country of the location on the pow. They can be found here: https://www.iso.org/obp/ui/#search	mandatory	Yes	Yes
LocationPrimaryCode	Max. 5 digit field for the Primary location code (PLC) of the location on the particular row. (available at: https://teleref.era.europa.eu/ , enter them without the country ISO code)	mandatory	Yes	Yes
Name	The location name (https://teleref.era.europa.eu/)	optional	Yes	Yes
TrainActivity	This field is used to indicate the train activity at the particular location. The overview of activities is in the sheet Code list. The values shall be provided with their 4-digit codes and comma-separated if more activities are executed in the same location, for instance; 0001,0013 (=commercial stop, attach wagon).	optional	Yes	Yes
ELA	Earliest arrival time (hh:mm)	optional	Yes	Yes
ELD	Earliest departure time (hh:mm)	optional	Yes	Yes
ALA	Actual arrival time (hh:mm)	optional	Yes	Yes
ALD	Actual departure time (hh:mm)	optional	Yes	Yes
LLA	Latest arrival time (hh:mm)	optional	Yes	Yes
LLD	Latest departure time (hh:mm)	optional	Yes	Yes
DwellTime	For the min. dwell time on the location in minutes (mm)	optional	Yes	Yes
MaxJourneyTimeSection	It shall be used only for the CNAs to indicate the limit of the journey time from a location to the next location, wished by the applicant (hh:mm)	optional	Yes	No
ResponsibleApplicant	Alphanumerical field (4 characters): company code of the applicant responsible for/from the location on this can be searched here: https://teleref.era.europa.eu/	optional	Yes	No
TrainWeight	The weight of the train including loco in tons	optional	Yes	Yes
TrainLength	The length of the train including loco in metres	optional	Yes	Yes
TrainMaxSpeed	The maximum possible speed of the train in km/h, provided by the Applicant	optional	Yes	No
PlannedSpeed	The speed in km/h that was or will be taken into account in the path construction, provided by the IM	optional	No	Yes
Acceleration	The acceleration information in m/s ² . Note that comma is used, not dot, to separate the decimal part (correct: 1,2 incorrect: 1.2)	optional	Yes	Yes
BrakeType	Only valid brake types can be selected, see the sheet Code list.	optional	Yes	No

BrakingRatio	The braking ratio for the selected brake type.	optional	Yes	No
NumberOfLocos	A number that indicates the number of traction units to be used for the future train indicated in the CNA.	optional	Yes	No
PushPullTrain	Write either 1 or 0. A boolean field that indicates if the train can change direction without shunting the loco around the train.	optional	Yes	No
RollingStockType	Indicate the Rolling stock type (see sheet Code list).	optional	Yes	No
ETCSOnBoard	Write either 1 or 0. A boolean field that indicates whether the train is equipped with any kind of ETCS option.	optional	Yes	No
P1	Belongs to the combined transport profile. It shall be fulfilled only for combined transport trains.	optional	Yes	Yes
C1	Belongs to the combined transport profile. It shall be fulfilled only for combined transport trains.	optional	Yes	Yes
P2	Belongs to the combined transport profile. It shall be fulfilled only for combined transport trains.	optional	Yes	Yes
C2	Belongs to the combined transport profile. It shall be fulfilled only for combined transport trains.	optional	Yes	Yes
DangerousGoodsIncluded	Write either 1 or 0. It's a boolean field that indicates whether the train includes any kind of dangerous goods.	optional	Yes	No
ExceptionalTransport	Write either 1 or 0. It's a boolean field that indicates whether the train is an exceptional transport.	optional	Yes	No
TiltingFunction	Write either 1 or 0. It's a boolean field, only for passenger trains, that indicates whether train is capable of tilting.	optional	Yes	No
ValidFrom	The start of the validity period of the object. YYYY-MM-DD	mandatory	Yes	Yes
ValidTo	The end of the validity period of the object. YYYY-MM-DD	mandatory	Yes	Yes
Monday	Part of the circulation days pattern, if the user does not want to provide daily bitmap for the calendar. Write either 1 or 0.	conditionally optional	Yes	Yes
Tuesday	Part of the circulation days pattern, if the user does not want to provide daily bitmap for the calendar. Write either 1 or 0.	conditionally optional	Yes	Yes
Wednesday	Part of the circulation days pattern, if the user does not want to provide daily bitmap for the calendar. Write either 1 or 0.	conditionally optional	Yes	Yes
Thursday	Part of the circulation days pattern, if the user does not want to provide daily bitmap for the calendar. Write either 1 or 0.	conditionally optional	Yes	Yes

Friday	Part of the circulation days pattern, if the user does not want to provide daily bitmap for the calendar. Write either 1 or 0.	conditionally optional	Yes	Yes
Saturday	Part of the circulation days pattern, if the user does not want to provide daily bitmap for the calendar. Write either 1 or 0.	conditionally optional	Yes	Yes
Sunday	Part of the circulation days pattern, if the user does not want to provide daily bitmap for the calendar. Write either 1 or 0.	conditionally optional	Yes	Yes
TimeUnit	Only valid values can be selected (see sheet Code list). Then the applicant can provide a frequency for the selected Time unit in the defined validity period.	conditionally optional	Yes	No
Frequency	This field is connected with the TimeUnit filed for the defined TimeTableYear. If you select TimeUnit=weekly and write Frequency=1, it would mean 1 train run per week.	conditionally optional	Yes	No
BitmapDays	The length shall be in line with the selected validity period and it indicates a daily calendar of the object.	conditionally optional	Yes	Yes
Comment	Free text field	-	Yes	Yes

Annex F: Capacity Model evaluation

After X+12, when the appropriate timetable period ended, IMs should evaluate whether they were able to keep their previous commitment from the capacity partitioning. This knowledge is essential to gather data and improve the capacity partitioning and planning in the upcoming TT periods.

It is important to track:

- Whether the estimated share for TCRs was kept, and if not, for which reason. The IMs should also evaluate whether the TCR share was sufficient for maintenance in the long-term view. The evaluation of IMs should not be limited to a simple two per cent figures comparison, it has to be transparent and go deeper to the particular shares of TCR impact types and where needed even to particular TCRs. The stakeholders have to understand that special attention has to be given to the TCRs caused by force majeure, of which most are unpredictable. The evaluation should be done according to the Procedures for Temporary Capacity Restriction Management.
- The reliability of submitted CNAs by Applicants, if they requested the products designed for them by IMs and whether they were used for the train run.
- If the ratio of TCRs was in line with the planned amounts included into the traffic part of the Capacity Model.

The IMs should develop a joint methodology, how to evaluate Capacity Models, consult the methodology with Applicants and update this document.

Annex G: Calculation of intended capacity usage lines and unplanned capacities

The intended capacity usage lines, and the amount of the unplanned capacity can be calculated through different methods.

1. Based on historical data stemming from TIS/national traffic management system:

In the first step, the average number of trains within a period should be checked for each railway line.

Example:

The period of the morning rush hours (6-9 am):

- Between 6-7: 9 trains,
- Between 7-8: 8 trains,
- Between 8-9: 7 trains,
- The volume, which can be accommodated without paying special attention to capacity planning / extraordinary traffic management measures in the Capacity Model is 8 in the period between 6-9 am.

The same methodology can be applied for the other periods, as well.

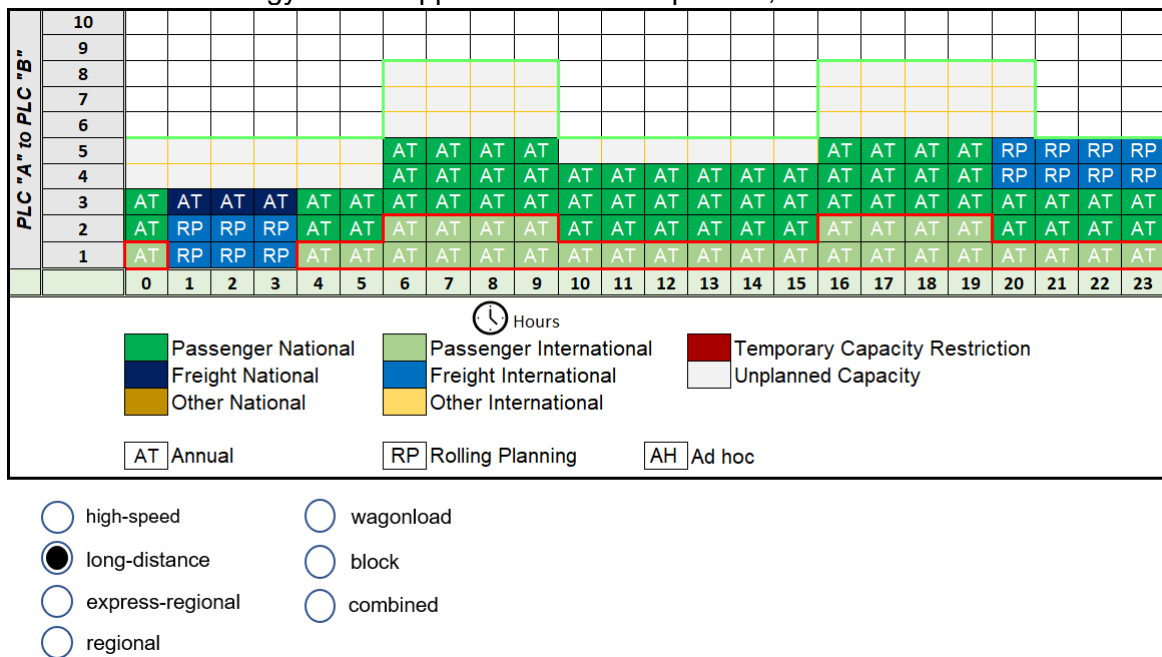

Example of the calculation of intended capacity usage line - 1

Based on the information gathered from RNE Train Information System (TIS)/national systems, the volumes, which can be accommodated without extraordinary traffic management measures are changing period by period on the analysed railway line.

The calculated values per hour shall be included into the model, as an intended capacity usage line, which means that the planned/unplanned capacities below this line can be used without any extraordinary efforts on IM side.

The intended capacity usage line can be calculated based on the following inputs:

- Railway line (mandatory) → the intended capacity usage should be calculated for every railway line.
- Primary Location Code level information (optional) → IMs have to opportunity to also share PLC level information and calculate the intended capacity usage line on PLC level.
- Period (mandatory) → It is possible to set one figure for the whole day or to set it for periods/hours.

During the preparation of the Capacity Model not all capacities have been filled with volumes, therefore, unplanned capacities remained for later utilisation. Taking into account, that one period is usually homogeneous (early morning → passenger, at night → freight are in majority) it can be stated, that these volumes define the majority in the period. According to our analysis the traffic mix does not change significantly over the TT periods.

The automatic calculation of the intended capacity usage is based on the bell curve theory. The bell curve represents the normal distribution of a dataset. The previous analysis has shown that the distribution of trains follows the normal distribution (or very close to that), which means the bell curve can be utilised.

On the horizontal axis, the value (e.g., number of trains) is presented, while on the vertical axis the number of days is shown. For instance, there were 2 days when 10 freight trains were operated on the line and only one day when 25 freight trains. It can be noted that these are extreme values (e.g., due to TCR less freight train operated) and can be neglected for the future analysis.

On average, 15.7 freight trains were on the line daily, so if the intended capacity line is defined a little bit above the average, then the system would already contain buffer and count with a possible future increase in the traffic. For example, as it is shown on the figure, in 80% of the cases there were maximum 19 freight trains on the line. This information can be utilised as the intended capacity usage line might be set at 19, meaning if the capacity would reach this value, it is highly probable that the IMs should interreact or the system can easily turn into an instable state.

With the help of the mentioned methodology, the intended capacity usage line can be calculated and set for any section The methodology of the model enables the IMs to avoid the extremes and to define the intended capacity usage line based on real data which can be later iteratively adjusted.

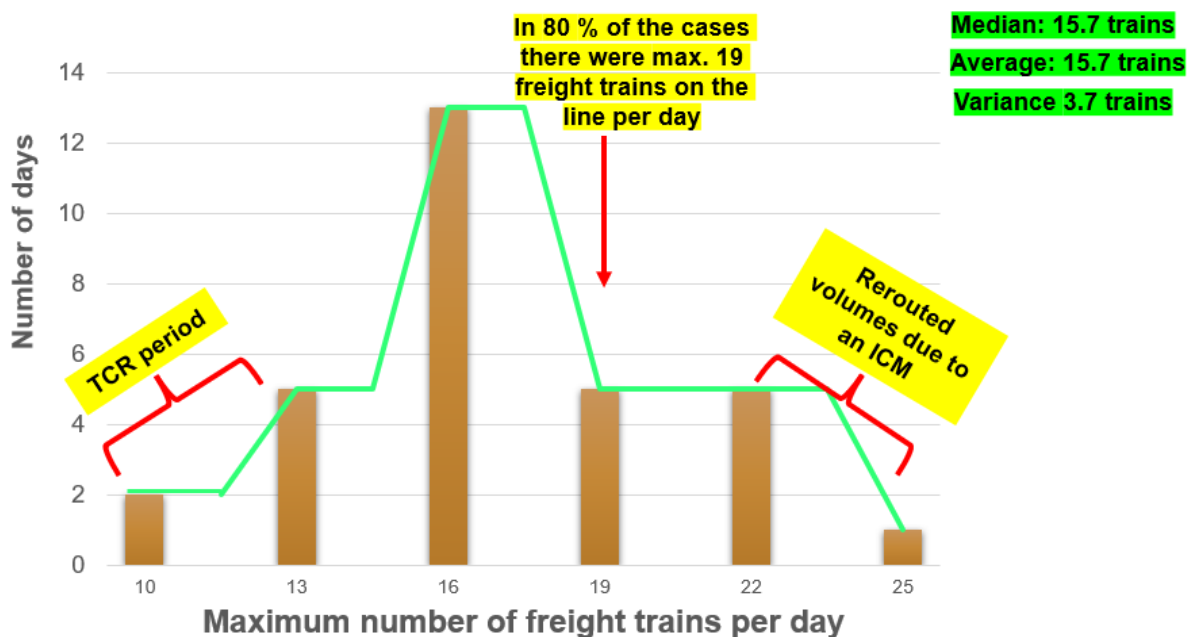

2. Own estimation of the IM

The IM can define the amount of volumes, which can run without extraordinary traffic management measures for the day, and the same value is valid for every hour.

The estimated value shall be included into the model, as an intended capacity usage line, which means that the planned/unplanned capacities below this line can be used without any extraordinary efforts on IM side.

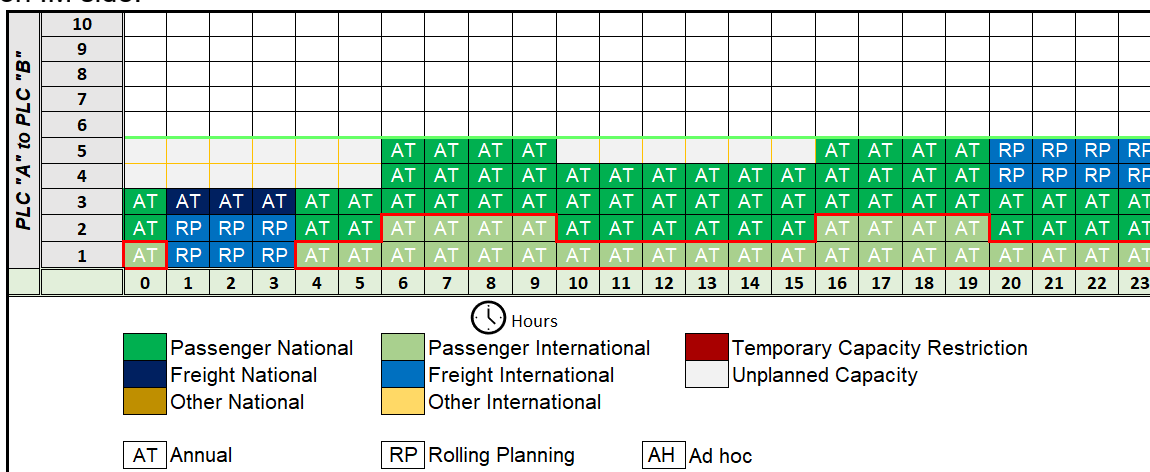

- high-speed
- long-distance
- express-regional
- regional
- wagonload
- block
- combined

Example of the calculation of intended capacity usage line - 2

Annex H: Process chart for creation of Capacity Model variants for TCR / TCR window periods

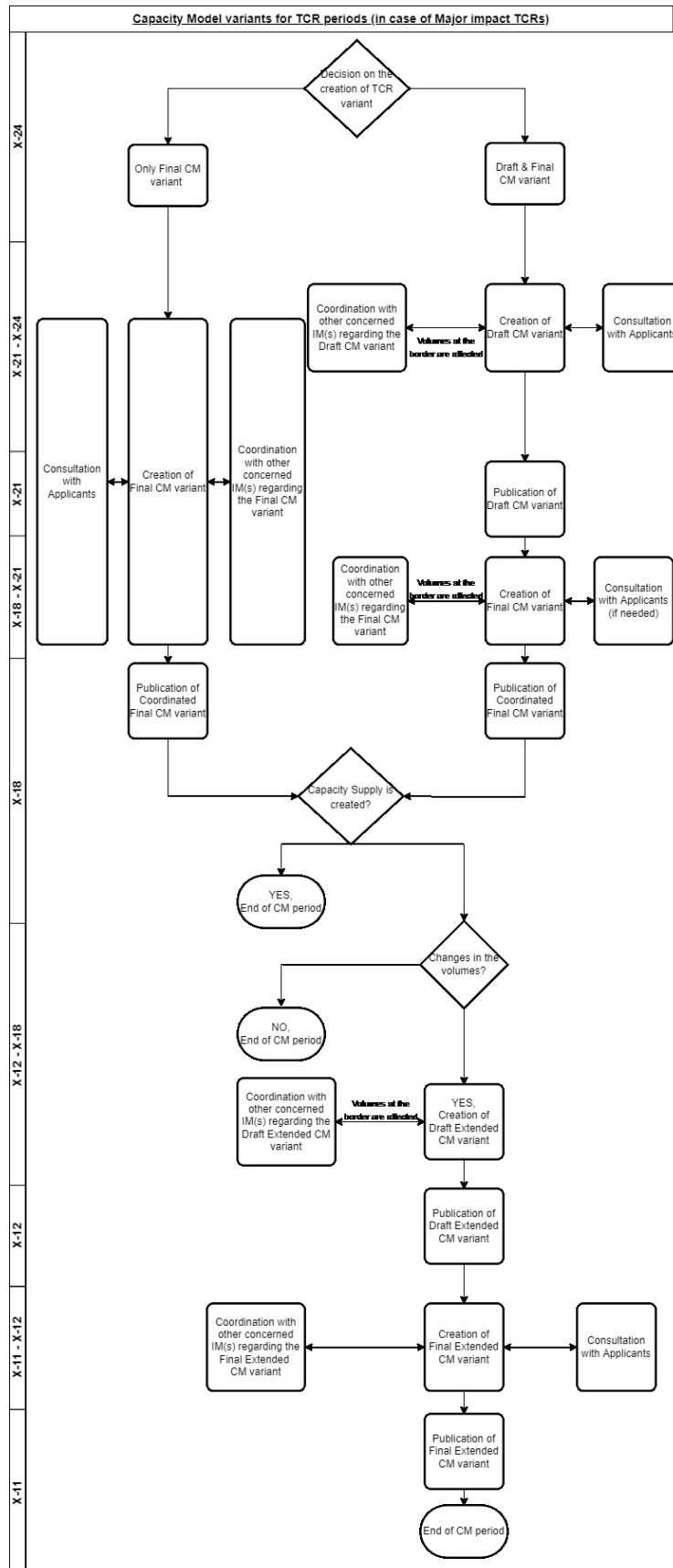

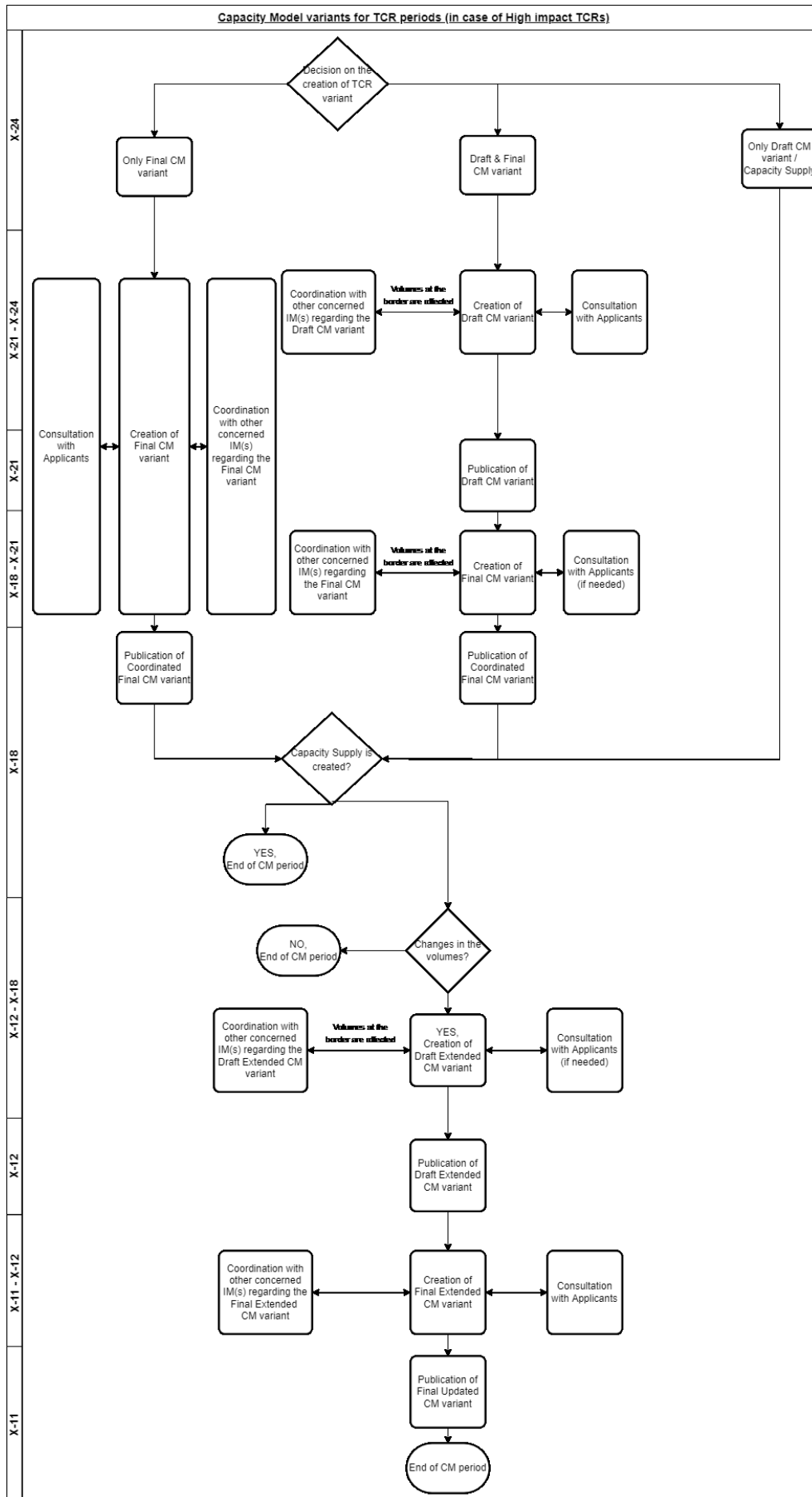

Annex I: Conflicting CNAs

To be updated

**Annex J: Changes in the submitted CNAs
(differentiation between significant/not-significant changes)**

To be updated